

DW9L Series 3 Phase Energy Meter Operation Manual



Edition and modification record

Date	Version	Modify content
2022.01.10	F/0	First File

Thank you for choosing our products. In order to facilitate you to use this instrument safely, correctly and efficiently, please read this manual carefully and pay attention to the following points when using it.



Note:

This equipment can only be installed by professional staff. The manufacturer will not be responsible for any damage caused by failure to follow the instructions in this manual.



Risk of electric shock, burning or explosion

- ※ Equipment can only be installed and maintained by qualified personnel.
- ※ Before making any operation, isolate the voltage input and power supply, and short-circuit the secondary windings of all current transformers.
- ※ Using a suitable voltage detection device to confirm that the voltage has been cut off.
- ※ Before the equipment is powered on, all mechanical parts, doors and covers should be returned to their original positions.
- ※ Provide correct rated voltage to the meter when using it.

Any operation not following the manual will cause accident or damage to the product !

Information provided in this manual can be modified without prior notice.
The company reserves the right of information updation.

Index

1 Product overview	1
1.1 This instrument implements relevant national standards	1
1.2 Features and applications	1
1.3 Product function list	2
1.4 Measurement parameters	2
2 Technical indicators	3
3 Installation and wiring	4
3.1 Loading list	4
3.2 Shape and installation hole size	4
3.3 Installation method	4
3.4 Terminal diagram	4
3.5 Terminal corresponding wiring table	5
3.6 Signal wiring diagram	6
3.7 Auxiliary power supply	7
3.8 Relay output	7
3.9 Switch input	7
3.10 Analog transmission output	7
3.11 Energy pulse output	7
3.12 Communication output	8
4 Operation instructions	8
4.1 Panel diagram	8
4.2 Display area description	8
4.3 Key button description	8
4.4 26 English letters display method on LED	9
4.5 Measurement display page description	9
4.6 Menu modification instructions	10
4.7 Menu modification example	12
4.8 Multi-rate setting instructions	13
4.9 Alarm output and transmission output parameter	14
5 Simple troubleshooting	14
6 Event record description	15
6.1 Event type	15
6.2 Event record format	15
6.3 Reading event records	15
7 Communication protocol description	16
7.1 MODBUS-RTU protocol Introduction	16
7.2 Communication frame format description	16
7.3 Power meter communication address mapping	18
8 DLT645 communication description	23
8.1 Overview	23
8.2 DLT645 communication address correspondence table	23

I. Product Description

1.1 The instrument implements relevant national standards

DL/T 614-2007	<Multi-function Energy Meter>
GB/T 17215.301-2007	<Multifunction Harmonic Meter Special Requirements>
GB/T 17215.322-2008	< 0.2 and 0.5 Class Static AC Active Power Meter>
GB/T 17215.323-2008	< 1 and 2 Class Static AC Reactive Power Meter>
DL/T 645-2007	<Multi-function Energy Meter Communication Protocol>
GB/T 15284-2002	<Multi-tariff rate electric energy meter special requirements>
GB/T 14549-1993	<Power quality public grid harmonics>
GB/T 15543-2008	<Admissible three-phase voltage unbalance>

1.2 Features and Application

This instrument with high performance-price ratio, can directly replace common measurement indication meter, energy meter, harmonics measure instruments ect. As an advanced intelligent and digital power grid front-end acquisition component, it can be used in various control systems. It has features of easy to install, simple wiring, easy maintenance, small engineering quantity, field programmable input parameters etc, also can communicate with various PLC, industrial control computers.

Main Features:

- ※ Large size LCD display, simple and convenient operation, rich interface information;
- ※ Measure parameters such as U, I, P, Q, S, P, F, Hz etc.
- ※ With 4-quadrant reactive power record function;
- ※ Measure forward and reverse energy, realizing 12 time periods multi-rate energy metering;
- ※ With demand statistics function, support U, I maximum value record function;
- ※ Measure the 2-31 harmonics content and total harmonic distortion rate THD of voltage and current in power network
- ※ Measure voltage and current unbalance and other power grid quality parameters;
- ※ Support 4 digital input (DI) function, adopts dry contact signal input mode
- ※ Support 2 relays (250V/5A) digital output (DO) function, output and remote control in various places;
- ※ Support one loop active energy pulse, one loop reactive energy pulse output;
- ※ Support One RS485 communication, MODBUS-RTU communication protocol (optional DLT645 protocol);
- ※ Optional one 4-20mA analog output;

Typical Application:

- ※ Energy Management System
- ※ Power Monitoring System
- ※ Intelligent Building
- ※ Smart Switchboard
- ※ High and low voltage switch cabinet
- ※ Distribution network automation

1.3 Function List

Function		DW9L-IRC38	DW9L-RC38
Real-time measurement	3 phase voltage	●	●
	Grid Frequency	●	●
	3 phase current	●	●
	Zero phase current	●	●
	3 phase active power	●	●
	3 phase reactive power	●	●
	3 phase apparent power	●	●
	3 phase power factor	●	●
	Positive sequence,negative sequence,zero sequence	○	○
	Energy Measurement	Active Power	●
	4-quadrant reactive power	●	●
Power Quality	Maximum value of voltage and current	●	●
	Unbalance of voltage and current	●	●
	Total Harmonic Content	●	●
	32nd times harmonics content rate of voltage	●	●
	32nd times harmonics content rate of current	●	●
Multi-rate	4 tariff rates, 12 time periods measurement	●	●
Demand	Active Power, reactive Power, maximum demand record	●	●
Clock	With real-time clock which can be timed	●	●
Event Record	Undervoltage, overvoltage, undercurrent, overcurrent	○	○
	Alarm Action	○	○
	Programming parameters	○	○
	Clear energy, demand, etc.	○	○
Energy Pulse	1 loop active energy, 1 loop reactive energy	2	2
Analog Output	One 4~20mA analog output	1	No
DI (digital input)	Passive dry contact	4	4
Alarm Output	AC250V/5A Remote control/ alarm	2	2
Communication	RS485: support MODBUS-RTU/DLT645-2007	1	1
Display	Large size LCD display	●	●
Size	Hole Size	92*92mm	92*92mm
	Dimensions	96*96*100mm	96*96*100mm

Remark: "●" standard ; "○" optional

1.4 Measurement Parameter Range

Measurement Parameter	Indirect Measurement Range	Accuracy
Voltage	2.0V~500KV	0.2%
Current	0.02A~6000A	0.2%
Active Power	1W~100MW (negative consistent)	0.5%
Reactive Power	1var~1000Mvar (negative consistent)	0.5%
Apparent power	1VA~100MVA	0.5%
Power Factor	-1.000~1.000	0.5%
Frequency	30Hz~500Hz	0.2%
Active Energy	0~999999.99kWh(note)	0.5%
Reactive Energy		2%

Note: Energy metering is a secondary-side value. Please multiply the PT and CT values when you measure the electric energy.

II. Technical Parameters

Item		Performance parameters	
Input Measurement Display	Network	3 phase 4 wires/ 3 phase 3 wire/ Single phase	
	Voltage	Rated value	AC3x220V/380V
		Overload	Continuous:1.2 times Instantaneous:2 times/2s
		Power Consumption	<0.6VA (each phase)
		Impedance	>500kΩ
		Accuracy	RMS measurement, Accuracy 0.2%
	Current	Rated Value	AC 0.02-6A
		Overload	Continuous: 1.2 times Instantaneous: 2 times/2s
		Power Consumption	<0.4VA (each phase)
		impedance	<20mΩ
		Accuracy	RMS measurement, Accuracy 0.2%
	Frequency	50-60Hz, accuracy 0.01Hz	
	Power	Active, reactive, apparent power, accuracy: 0.5%	
	Harmonic	Power, Harmonic Accuracy: A	
	Energy	Active power: accuracy 0.5S; reactive power: accuracy 2	
Clock	Clock error: 0.5s/d (Reference temperature: 23℃)		
Display	Large screen segment LCD display		
Current	Power Supply	AC/DC 100V ~ 240V	
	Consumption	<8VA	
Output	Communication	1. RS485 Communication; 2. Correspond international standard MODBUS-RTU protocol 3. Correspond national standard DLT645-2007 protocol; 4. Communication Baud Rate: 1200,2400,4800,9600,19200; 5. Checking Method: optional no parity, even parity, odd parity	
	Pulse	Passive optocoupler collector output	
	Alarm Output	Relay output: capacity: 5A/250VAC or 5A/30VDC; programmable alarm or remote control mode;	
	Analog Output	4-20mA current analog output	
	Digital Input (DI)	Remote signal: passive dry junction input	
Environment	Working Environment	-10 ~ 55℃	
	Storage Environment	-20 ~ 75℃	
Safety	Withstand voltage	Input and power >2kV, Input and output>2kV	
	Insulation	Input, output, Power Supply VS Case>50MΩ	
Electromagnetic Compatibility	Electrostatic discharge immunity	Correspond GB/T 17626.2-2006 3 level	
	Electrical fast pulse group immunity	Correspond GB/T 17626.4-2008 4 level	
	Surge immunity	Correspond GB/T 17626.5-2008 4 level	
	RF conducted immunity	Correspond GB/T 17626.6-2008 4 level	
	Power frequency magnetic field immunity	Correspond GB/T 17626.8-2006 4 level	
	Radiation immunity	Correspond GB/T 17626.3-2006	

III. INSTALLATION AND WIRING

3.1 Loading List

Meter	Mounting brackets	Instructions	Certification
1 (PC)	1 (Set)	1 (PC)	1 (PC)

3.2 Shape and mounting hole size

Model (mm)	Case Size (mm)	Hole Size (mm)	Minimum installation distance		Length(mm)
			Horizontal Direction	Vertical direction	
96×96	91×91	92×92+0.5	120	120	100

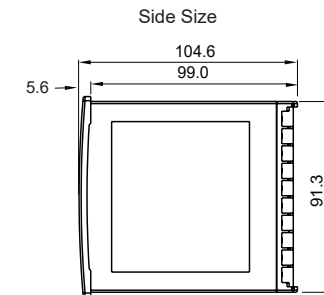
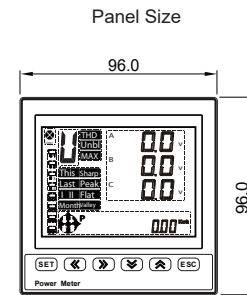

3.3 Installation method (as shown in the right figure)

- 1) Open 92*92 (mm) hole in fixed distribution cabinet;
- 2) Remove the meter and take out the fixed bracket;
- 3) The instrument is pressed into the mounting hole from the front;
- 4) Insert the instrument holder and tighten the screws to secure the meter

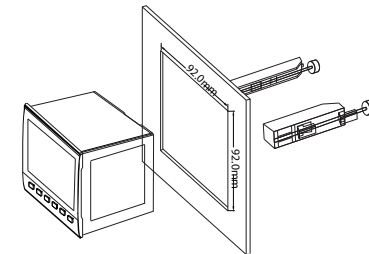

3.4 Instrument terminal diagram

		Rear view					
L(+)	1	Ua (Ua)	20	10	B-		
N(-)	2	Ub	21	11	A+		
NO	3	Uc (Uc)	22	12	COM		
NC	4	Un (Ub)	23	13	S1		
ACOM	5	IA*	24	14	S2		
NO	6	IA	25	15	S3		
NC	7	IB*	26	16	S4		
AO+	8	IB	27	17	RP		
AO-	9	IC*	28	18	AP		
	0	IC	29	19	PCOM		

3.5 Terminal corresponding wiring chart

Category	Corresponding terminal number	Corresponding letter	Input & output directions	Description
Power	1	L(+)	Input	Optional AC and DC power supply; Range: AC: 85 ~ 265V DC:100 ~ 240V
	2	N(-)	Input	
Alarm or remote control output	3	NO	Output	NO: 1st alarm open
	4	NC	Output	NC: 1st alarm close
	5	ACOM	Output	Alarm or remote control
	6	NO	Output	NO: 2nd alarm open
	7	NC	Output	NC: 2nd alarm close
Transmission Output	8	AO+	Output	4 ~ 20mA outflow positive
	9	AO-	Output	4 ~ 20mA outflow negative
Blank	0	Blank		Unused
Communication	10	B-	Output/Input	RS485 Negative communication
	11	A+	Output/Input	RS485 Positive communication
Switch Input	12	COM	Input	Switch input common (communication mask access point)
	13	S1	Input	Switch input 1st loop
	14	S2	Input	Switch input 2nd loop
	15	S3	Input	Switch input 3rd loop
	16	S4	Input	Switch input 4th loop
Energy Pulse	17	RP	Output	Reactive energy pulse poer
	18	AP	Output	Active energy pulse port
	19	PCOM	Output	Pulse output common port
Voltage Signal Input	20	UA (Ua)	Input	3 phase 4 wires A phase voltage input (3 phase 3 wires A phase voltage input)
	21	UB	Input	3 phase 4 wires B phase voltage input (3 phase 3 wires C phase voltage input)
	22	UC (Uc)	Input	3 phase 4 wires C phase voltage input (3 phase 3 wires C phase voltage input)
	23	UN (Ub)	Input	3 phase 4 wires 0 phase voltage input (3 phase 3 wires B phase voltage input)
Current Signal Input	24	IA*	Input	A phase current inflow
	25	IA	Input	A phase current outflow
	26	IB*	Input	B phase current inflow
	27	IB	Input	B phase current outflow
	28	IC*	Input	C phase current inflow
29	IC	Input	C phase current outflow	

Description

1. The brackets in the voltage input terminal indicate the 3 phase 3 wires connection
2. The current "*" is the current input terminal, all outgoing lines must be unified. Otherwise, the measurement will be inaccurate.
3. If there is any change in the wiring, please take the wiring diagram of the instrument case as the standard.

3.6 Connection Drawing

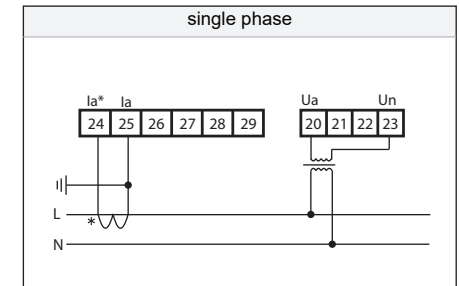
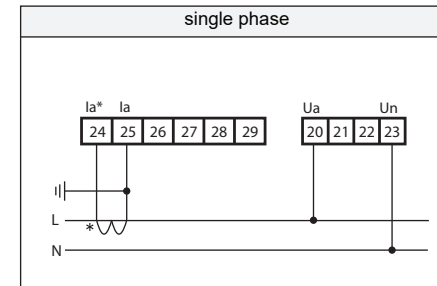
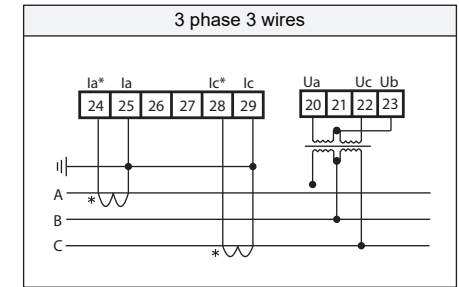
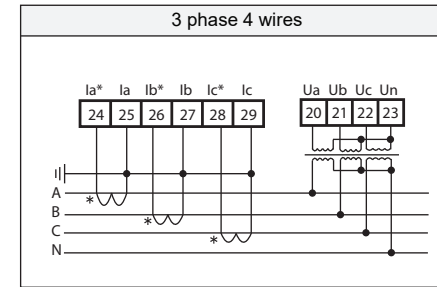
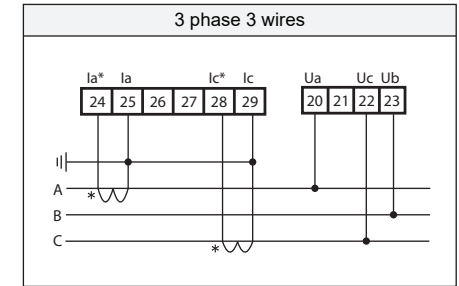
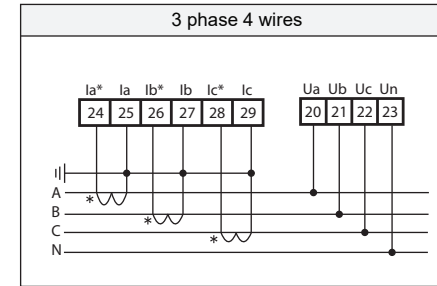

Note

1. When the input voltage is higher than the rated input voltage of the product, you should consider using a PT. For ease of maintenance, it is recommended to use a wiring board.
2. The standard rated input current is 5A, 1A or greater than 5A, the external CT should be used. If there are other meters connected to the CT, the wiring should be connected in series. Before removing the current input connection of the product, it is necessary to disconnect the primary circuit of the CT or short the secondary circuit. It is recommended to use the terminal block for maintenance.
3. To ensure that the input voltage and current correspond, the phase sequence is consistent and the direction is the same, otherwise there will be errors in the values and symbols of power and energy, etc.
4. The instrument can work in 3 phase 4 wires mode or 3 phase 3 wires mode. The user should select the appropriate wiring mode according to the field use conditions. The 3 phase 3 wires mode is generally used without a center line, and the 3 phase 4 wires mode is used with a center line. It should be noted that the on-site wiring must be the same as the wiring set in the meter, otherwise the meter's measurement data is incorrect.

3.7 Power Supply

The instrument has a universal (AC/DC) power input interface. If no special explanation is given, it is a standard product of AC220V power interface. The limit working voltage of the instrument is AC 85-265V. Please ensure that the supplied power is suitable for this series. Products to prevent damage to the product. Also recommended:

1. It is recommended to use AC power to install 1A fuse on the side of the line of fire;
2. For areas with poor network quality, it is suggested that a surge suppressor be installed in the power circuit to prevent lightning strikes and a fast pulse train suppressor be installed.

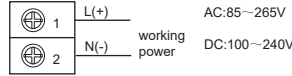

3.8 Relay output

This meter with relay output function can be used for alarm indication and protection control output function in various occasions. When the digital output is valid, the relay output is on, and when the digital output is off, the relay output is off.

1. High Alarm : When the high alarm indicates that the alarm threshold is higher than the alarm item, the relay switch output turns on.
2. Low Alarm : When the low alarm indicates that the alarm threshold is lower than the alarm item, the relay switch output turns on;
3. Remote control relay : If the relay output control is selected as the remote control mode, the output of the relay is set to "remote control" through the programming operation, and the output of the relay can be controlled through communication.

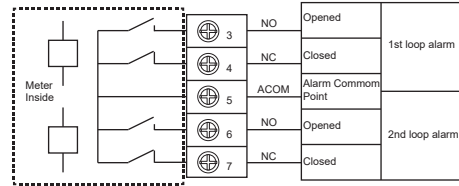

3.9 Switch Input

The instrument has a switch input detection function and adopts the dry node signal input method. The instrument is equipped with a +24V working power supply inside, and no external power supply is required. When it is connected externally, it is collected by the instrument switch input module DI, and the interface shows that it is in the open state. When it is disconnected externally, it will be disconnected through the digital input module DI of the instrument collector, and the interface will be in the open state.

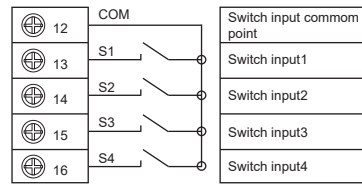

3.10 Analog output

The instrument has an analog output function and can be set by any of 26 power levels. The analog output of the instrument can be used to achieve the analog output function of the electrical parameters (4-20mA).

Electrical parameters: Output: 4-20mA

- Accuracy: 0.5s
- Overload: 120% effective output maximum current 24mA
- Load : Rmax = 600Ω

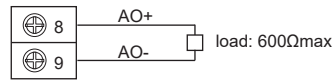

3.11 Energy Pulse Output

Energy metering and pulse output: the meter provides positive and negative active energy metering, 2 loops energy pulse output functions and RS485 digital interface to complete the display and remote transmission of energy data. The energy pulse (resistance signal) of the photocoupler relay with open-collector level is used to realize the remote transmission of active energy (forward) and reactive energy (forward), and the remote computer terminal, PLC and DI switch acquisition module is used to collect the instrument. The total number of pulses to achieve energy cumulative measurement. Use the pulse output method to check the accuracy of the electrical energy (national measurement procedures: comparison method of pulse error of the standard form)

1. Electrical characteristics: VCC<=48V IZ<=50mA in the circuit diagram of the pulse acquisition interface
2. Pulse constant: 9000 imp/kWh(kvarh), the fastest pulse speed does not exceed 200mS. Its significance is: when the meter accumulates 1kWh (1kvarh) output pulse number is 9000.

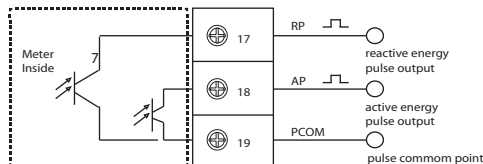

3.12 Communication Output

The device has a two-wire RS-485 communication port with terminals labeled A+, B-. High-speed optocoupler isolation and protection circuits prevent common-mode and differential-mode voltage interference, lightning strikes, and miswiring from damaging the communications port. The RS-485 communication mode allows a maximum of 32 instruments to be connected on one bus. In this case, an RS-232C/RS-485 converter is required. The communication cable can be an ordinary shielded twisted pair cable. The total length cannot exceed 1200 meters. The positive and negative polarity of the RS-485 port of each device must be connected correctly, and one end of the cable shield is grounded. If the shielded twisted pair is long, it is suggested to connect a 120Ω resistor at the end to improve the reliability of communication.

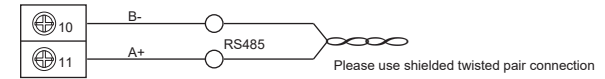

IV. OPERATION INSTRUCTIONS

4.1 Panel diagram

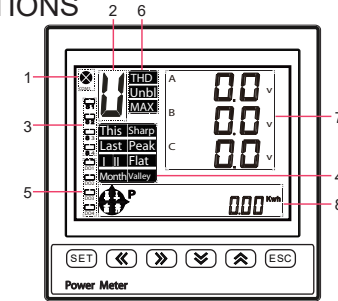

4.2 Display Area Description

No.	Display Description																
1	Communication indicator: The indicator will keep blinking while it is passing																
2	Display the current display category of the data display area: like the voltage corresponds to "U", the current corresponds to "A", etc.																
3	Switch input indicator, when a certain amount of switch is closed, the corresponding switch display frame will be filled with solid. If the second way switch is turned on, the display state is as follows:																
4	Indicating the corresponding rate of multi-rate: <table border="0" style="margin-left: 20px;"> <tr> <td>This Month</td> <td>indicate this month</td> <td>Sharp</td> <td>indicate"sharp"</td> </tr> <tr> <td>Last I Month</td> <td>indicate last month</td> <td>Peak</td> <td>indicate"peak"</td> </tr> <tr> <td>Last II Month</td> <td>indicate last two months</td> <td>Flat</td> <td>indicate"flat"</td> </tr> <tr> <td></td> <td></td> <td>Valley</td> <td>indicate"valley"</td> </tr> </table>	This Month	indicate this month	Sharp	indicate"sharp"	Last I Month	indicate last month	Peak	indicate"peak"	Last II Month	indicate last two months	Flat	indicate"flat"			Valley	indicate"valley"
This Month	indicate this month	Sharp	indicate"sharp"														
Last I Month	indicate last month	Peak	indicate"peak"														
Last II Month	indicate last two months	Flat	indicate"flat"														
		Valley	indicate"valley"														
5	Alarm or remote output indicator: When an alarm occurs, the corresponding output indicator will be filled with solid. Such as:																
6	THD Indicate total harmonic content Unbl Indication imbalance MAX Indicates the maximum																
7	Measurement data real-time display area, can display the voltage, current, power etc																
8	Power display area: Measurement range is 0~999999.99, Exceeding the maximum will automatically flip																

4.3 Key Description Form

Key symbol	Key Name	Measurement Mode	Setting Mode	
			Parameter selection status	Parameter modification status
	Confirm Key	1. short press to switch display categories: instantaneous electrical parameters→ voltage harmonic→current harmonic→ Multi-rate electricity 2. long press to enter setup menu	enter the next menu	confirm the changes
	Left shift key	backward turning in the display class	visit last parameter	cursor left
	Right shift key	forward turning in the display class	visit next parameter	cursor right
	Reduce key	lower power display switch back	enter the parameter modification status	decrease of value
	Increase key	lower power display forward switch	enter the parameter modification status	increase of value
	Return key	short press for the lower power display column and return to integrated active power display	exit the last operation until you exit the setup menu	



4.4 26 English letters display method on LED:

Because this instrument uses a pen-type liquid crystal, it may not be intuitive when displaying characters. Therefore, when reading ambiguity occurs, please check according to the following form. The characters that appear in the instrument have been mapped to the following form.

English letter	A	B	C	D	E	F	G	H	I	J	K	L	M
Display method	A	b	c	d	E	F	G	H	i	J	k	L	m
English letter	N	O	P	Q	R	S	T	U	V	W	X	Y	Z
Display method	n	o	p	q	r	s	t	u	v	w	x	y	z

4.5 Measurement display page description

- Press "SET" key to switch display categories, namely, instantaneous electrical parameters → voltage subharmonic → current subharmonic → complex rate → instantaneous electrical parameters;
- In a certain display class, the display is displayed by pressing the "«" and "»" keys;
- In the instantaneous electrical parameters, voltage sub-harmonics, and current sub-harmonics, the energy can be viewed through the "≈" and "⋈" keys, which are: integrated active energy → positive active energy → negative active energy → integrated reactive energy → positive reactive energy → negative reactive energy → first quadrant reactive energy → second quadrant reactive energy → third quadrant reactive energy → fourth quadrant reactive energy

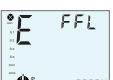
Display category	Display content	
Instantaneous electrical parameters 	Screen 1	3 phase voltage (press"ESC" key to display 3 phase wire voltage)
	Screen 2	3 phase current
	Screen 3	3 phase active power
	Screen 4	3 phase reactive power
	Screen 5	3 phase apparent power
	Screen 6	3 phase power factor
	Screen 7	Combined power and power factor
	Screen 8	system frequency
	Screen 9	Current demand
	Screen 10	Maximum demand
	Screen 11	Voltage imbalance
	Screen 12	Current imbalance
	Screen 13	maximum voltage
	Screen 14	maximum current
	Screen 15	total harmonic content of voltage
	Screen 16	total harmonic content of current
	Screen 17	0 phase current
Voltage Harmonics 	Screen 1	3 phase voltage 2nd harmonic content
	:	:
	Screen 30	3 phase voltage 31th harmonic content
Current Harmonics 	Screen 1	3 phase current 2nd harmonic content
	:	:
	Screen 30	3 phase current 31th harmonic content
Multi-rate electricity 	Screen 1	date
	Screen 2	time
	Screen 3	monthly sharp energy
	Screen 4	monthly peak energy
	Screen 5	monthly flat energy
	Screen 6	monthly valley energy
	:	:
	Screen 13	flat energy last two month
	Screen 14	valley energy last two month

4.6 Menu Operation Illustration

Under user menu status

- Press "SET" key more than 3 second, if the user password is set, it will pop up the password input box, input the correct password to enter the user' menu to modify the parameter.
- If the current display is the first class, press confirm key "SET", to enter next class display, click "«", "»" key to change the menu item
- If the current display is second or third class, press "ESC" key to return to previous class display
- If the current display is third class, press "≈", "⋈" key to flash digit, press key "«", "»" to shift place
Keep pressing "≈", "⋈"
to change value; press confirm key "SET" to keep the value; If press the "ESC" key, it does not save the set value and return to second class.
- After modifying the parameters, press "ESC", to exit user menu, return to measuring status.

Menu Structure and Function Description

1st Level	2nd Level	3rd Level	Description
System Setting SEt	Clear Energy CLrE	0000	Input "1111"to clear energy;Input "2222"to clear maximum demand; Input "3333" to clear event; Input"4444"to clear the maximum of voltage, current; input "1234" to reset to factory setting
	User password USER	0000	Setting user password
	Backlight time bLt	0000	Backlight delay time , unit is second . If set as 0 , mean keep on lighting all the time.
	Software version VER	1.1	Software version
	Signal Input INP	Network Lin	3-3/ 3-4
Volt transform Pt1		0.1-999.9	Primary coil voltage , unit kV
Volt transform Pt2		10.0-999.9	Secondary coil voltage , unit V
Current transform Ct1		1-999.9	Primary coil current , unit A
Current transform Ct2		10-999.9	Secondary coil current ,unit A
Comm. Parameter CoN		Address Add	1-247
	Baud Rate bAd	1k2/2k4/ 4k8/9k6	Baud Rate:1k2 means 1200, 2k4 means 2400, 4k8means 4800, 9k6 means 9600, 19k means19200
	Data order dEF	HL / LH	Data sequence: high word first or low word first
	Checking Bit Prty	no/EVEN/odd	No check/even check/odd check
	Protocol Selection CoD	noD6/d645	MODB: select MODBUS-RTU protocol D645:select DLT645 protocol
	ADD 1 Id1	0-99	RS5485 address 1, two decimal number display
	ADD 2 Id2	0-99	RS5485 address 2, two decimal number display
	ADD 3 Id3	0-99	RS5485 address 3, two decimal number display
	ADD 4 Id4	0-99	RS5485 address 4, two decimal number display
	ADD 5 Id5	0-99	RS5485 address 5, two decimal number display
ADD 6 Id6	0-99	RS5485 address 6, two decimal number display	

Continued from the front chart

Switch Settings	Alarm mode	AdI	1-68	When character " do " is remote control mode, otherwise it is alarm mode reference "4.9 alarm, transmission parameter comparison chart"
	Alarm Unit	Uti	1/ 2/ 3	1: means international standard unit, K: means 1000 times of international standard unit, M: means 1000000 times of international standard unit.
	Alarm Action Value	ALi	0-999.9	1st alarm value setting, consistent with the basic display unit
	Alarm hysteresis value	HYi	0-999.9	1st alarm hysteresis value setting, consistent with the basic display unit
	Alarm relay setting	oUti	rL91/rL92	1st alarm relay output setting
	Alarm start delay	dLRi	0-99	alarm start delay time , unit : second
	Alarm finish delay	dLbi	0-99	alarm finish delay time , unit : second
2nd loop alarm parameter setting way refers to the 1st loop alarm				
Analog output	Transmit mode selection	brn	0-32	Refer to "4.9 alarm, transmission parameter comparison chart"
	Transmit unit	Utr	1/ 2/ 3	1: means international standard unit, K: means 1000 times of international standard unit, M: means 1000000 times of international standard unit.
	Transmit high limit	brH	0-999.9	Transmit output 20mA
	Transmit low limit	brL	0-999.9	Transmit output 4mA
Time setting	Year	YERr	0-99	Year
	Month	non	1- 12	Month
	Day	dRY	1-3 1	Day
	Hour	HoUr	0-23	Hour
	Minute	ni n	0-59	Minute
	Second	SEc	0-59	Second
	Multi-rate setting	Period 1 rates	FL1	0-3
	Period 2 rates	FL2	0-3	Period 2 rates, 0,1,2,3 stands sharp, peak, flat, valley
	:	:	:	:
	Period 12 rates	FL12	0-3	Period 12 rates, 0,1,2,3 stands sharp, peak, flat, valley
	Period 1 Start time	Ft1	0000-2345	Period 1 Start Time
	Period 2 Start time	Ft2	0000-2345	Period 2 Start Time
	:	:	:	:
	Period 12 Start time	Ft12	0000-2345	Period 12 Start Time

4.7 Menu modification example

1. Setting the current ratio method

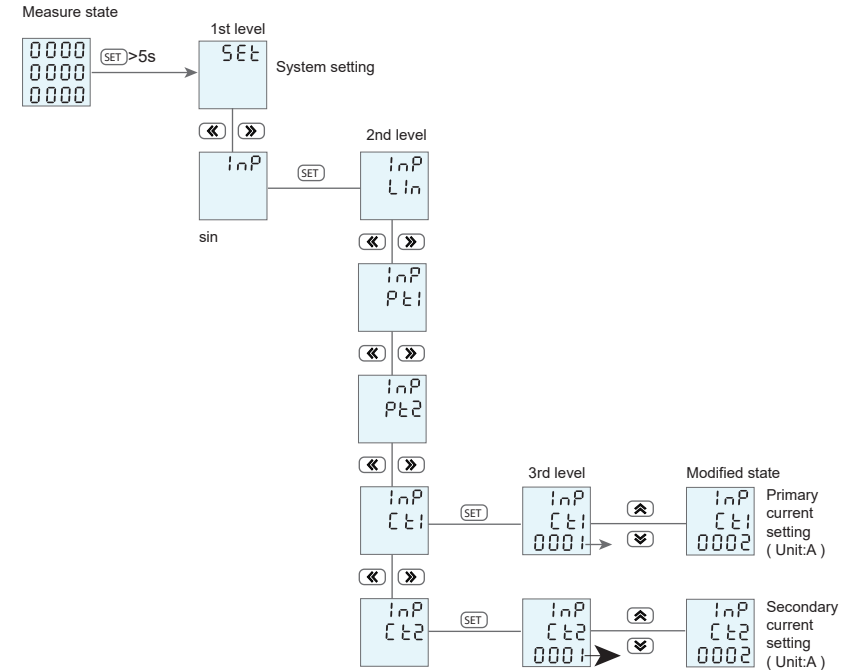

2. Setting the communication address method

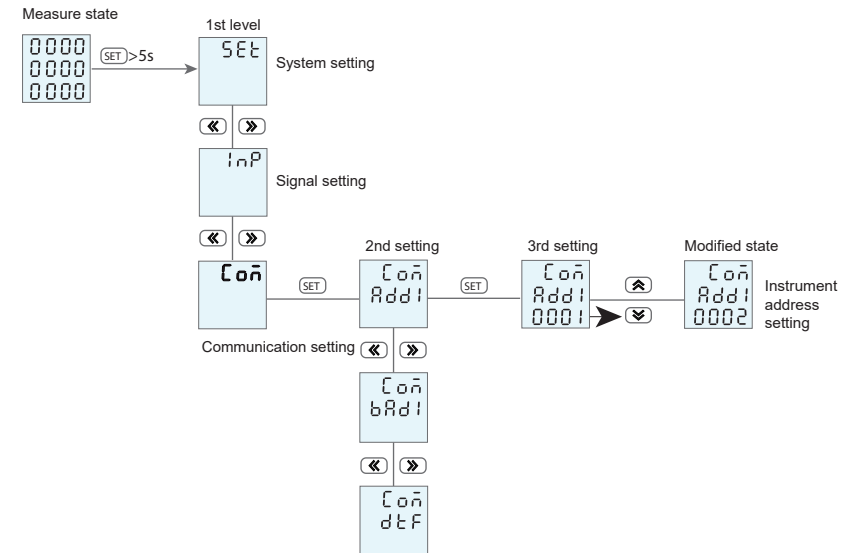

4.8 Multi-rate setting instructions

- The 0, 1, 2, and 3 in the rate menu correspond to Sharp, Peak, Flat, and Valley rates, respectively. Customers can choose to use Two or more of these rates;
- The rate corresponds to the start time of the rate in that period. Similarly, customers can use only 2 or more of these hours.
For example: The sharp, peak, flat, valley time set as follows
Peak hours: 09:00-11:30、14:00-16:30、19:00-21:00 (total 7 hours) ;
Flat hours: 07:00-09:00、11:30-14:00、16:30-19:00、21:00-23:00 (total 9 hours) ;
Valley hours: 23:00- next time 07:00 (total 8 hours)

The meter settings are as follows

Rate menu	Setting value	Remark	Time menu	Setting value	Remark	Corresponding communication value (note)
FL1	2	Flat	FT1	07.00	07:00	28
FL2	1	Peak	FT2	09.00	09:00	36
FL3	2	Flat	FT3	11.30	11:30	46
FL4	1	Peak	FT4	14.00	14:00	56
FL5	2	Flat	FT5	16.30	16:30	66
FL6	1	Peak	FT6	19.00	19:00	76
FL7	2	Flat	FT7	21.00	21:00	84
FL8	3	Valley	FT8	23.00	23:00	92
FL9	3	Valley	FT9	23.00	23:00	92
FL10	3	Valley	FT10	23.00	23:00	92
FL11	3	Valley	FT11	23.00	23:00	92
FL12	3	Valley	FT12	23.00	23:00	92

Note: For correspondence, the corresponding multi-rate period is divided into 96 segments by 15 minutes per day for 24 hours a day, from 0-95,0 to 00:00 for a 24-hour system, and 95 to 24:45 for a 24-hour system, corresponding to the time it is the start time of the rate energy during this period.

Multiple rate schedule correspondence form											
hour	minute	period	hour	minute	period	hour	minute	period	hour	minute	period
0	: 0	0	4	: 0	16	8	: 0	32	12	: 0	48
0	: 15	1	4	: 15	17	8	: 15	33	12	: 15	49
0	: 30	2	4	: 30	18	8	: 30	34	12	: 30	50
0	: 45	3	4	: 45	19	8	: 45	35	12	: 45	51
1	: 0	4	5	: 0	20	9	: 0	36	13	: 0	52
1	: 15	5	5	: 15	21	9	: 15	37	13	: 15	53
1	: 30	6	5	: 30	22	9	: 30	38	13	: 30	54
1	: 45	7	5	: 45	23	9	: 45	39	13	: 45	55
2	: 0	8	6	: 0	24	10	: 0	40	14	: 0	56
2	: 15	9	6	: 15	25	10	: 15	41	14	: 15	57
2	: 30	10	6	: 30	26	10	: 30	42	14	: 30	58
2	: 45	11	6	: 45	27	10	: 45	43	14	: 45	59
3	: 0	12	7	: 0	28	11	: 0	44	15	: 0	60
3	: 15	13	7	: 15	29	11	: 15	45	15	: 15	61
3	: 30	14	7	: 30	30	11	: 30	46	15	: 30	62
3	: 45	15	7	: 45	31	11	: 45	47	15	: 45	63

4.9 Alarm output and transmission output parameter

Parameter	Switch output (low alarm) code	Switch output (high alarm) code	Transmission output (4-20mA) code
Ua(A phase voltage)	1 (UaL)	2 (UaH)	1 (Ua)
Ub(B phase voltage)	3 (UbL)	4 (UbH)	2 (Ub)
Uc(C phase voltage)	5 (UcL)	6 (UcH)	3 (Uc)
U(phase voltage of A, B or C)	7 (UL)	8 (UH)	4 (no)
Uab(AB wire voltage)	9 (UabL)	10 (UabH)	5 (Uab)
Ubc(BC wire voltage)	11 (UbcL)	12 (UbcH)	6 (Ubc)
Uca(CA wire voltage)	13 (UcaL)	14 (UcaH)	7 (Uca)
UL(wire voltage of AB、BC、CA)	15 (ULL)	16 (ULH)	8 (no)
Ia(A wire current)	17 (IaL)	18 (IaH)	9 (Ia)
Ib(B wire current)	19 (IbL)	20 (IbH)	10 (Ib)
Ic(C wire current)	21 (IcL)	22 (IcH)	11 (Ic)
I(phase current of A、B、C)	23 (IL)	24 (IH)	12 (no)
Pa(A phase active power)	25 (PaL)	26 (PaH)	13 (Pa)
Pb(B phase active power)	27 (PbL)	28 (PbH)	14 (Pb)
Pc(C phase active power)	29 (PcL)	30 (PcH)	15 (Pc)
P(total active power)	31 (PL)	32 (PH)	16 (Ps)
Qa(A phase reactive power)	33 (QaL)	34 (QaH)	17 (Qa)
Qb(B phase reactive power)	35 (QbL)	36 (QbH)	18 (Qb)
Qc(C phase reactive power)	37 (QcL)	38 (QcH)	19 (Qc)
Q(total reactive power)	39 (QL)	40 (QH)	20 (Qs)
Sa(A phase apparent power)	41 (SaL)	42 (SaH)	21 (Sa)
Sb(B phase apparent power)	43 (SbL)	44 (SbH)	22 (Sb)
Sc(C phase apparent power)	45 (ScL)	46 (ScH)	23 (Sc)
S(total apparent power)	47 (SL)	48 (SH)	24 (Ss)
PFa(A phase power factor)	49 (PFaL)	50 (PFaH)	25 (PFa)
PFb(B phase power factor)	51 (PFbL)	52 (PFbH)	26 (PFb)
PFc(C phase power factor)	53 (PFcL)	54 (PFcH)	27 (PFc)
PF(total power factor)	55 (PFL)	56 (PFH)	28 (PFs)
F frequency	57 (FL)	58 (FH)	29 (F)
EP (total active power)	59 (EPL)	60 (EPH)	30 (EP)
EQ (total reactive power)	61 (EQL)	62 (EQH)	31 (EQ)
0 wire current	63 (InL)	64 (InH)	32 (In)
unbalance	65 (UNNB)	66 (ULNB)	0 (no)
unbalance	67 (INNB)	68 (PNNB)	

V. SIMPLE TROUBLESHOOTING

Problem	Reason	Solution
No display after adding control power	Power failed to join the device	Check whether the correct operating voltage is added to the L/+ and N/- terminals of the device Check if control power fuse is burned
The measurement value is incorrect or does not meet expectations	Incorrect voltage measurement	Check if the neutral connection is reliable Check whether the measured voltage matches the rated parameter of the equipment Check if the PT ratio parameter setting is correct
	Incorrect current measurement	Check whether the measured current matches the rated parameter of the device Check CT ratio parameter setting is correct
	Incorrect power measurement	Check the measurement mode setting is correct Check the voltage and current phase sequence is correct Check the current name is wrong
Switch status does not change	Switching voltage	Check whether the external node type matches the device's rated parameters Check the external wiring is correct
Relay does not operate	No control command received	Check the communication link is correct
	Incorrect relay operation mode	Check current relay is in correct mode
The upper end cannot communicate with the device	Device communication address is incorrect	Check whether the device address is consistent with the definition
	Device communication rate is incorrect	Check whether the device communication rate is consistent with the definition
	Communication link is not connected to terminating resistor	Check whether the 120 ohm resistor is added
	Communication link is disturbed	Check that the communication shield is well grounded
	Communication line interruption	Check the communication cable is disconnected

VI. EVENT RECORD DESCRIPTION

Event recording is currently an optional feature and can only be read through communications. The specific instructions are as follows:

6.1 Event Types

Including the followed 10 types:

No.	Correspondence data	Event Description
1	1	Power on the meter
2	2	modified parameter
3	3	Clear Energy
4	4	Clear Demand
5	5	Clear Event
6	6	Clear maximum
7	7	1st alarm action
8	8	1st alarm end
9	9	2nd alarm action
10	10	2nd alarm end

6.2 Event Record Format

Event Type	Event Occurred Time					
	Year	Month	Day	Hour	Minute	Second
1-10						

A total of 32 groups of events were included, both of which included event types and times. The event record uses a sequential recording method: the first record is always the most latest event and extends back to a total of 32 records.

6.3 Reading of event records

ADD	Order	Data ADD	Data length	CRC
XX	03	45 XX	00 07	XX XX

Eg, To read the latest first record, the data is as follows:

"01 03 45 00 00 07 13 EC"

Answers are as follows:

"01 03 0E 00 01 00 0E 00 09 00 12 00 11 00 07 00 21 0C F7"

Indicates that the event is a modified parameter. The moment of occurrence is 014-9-18 17:07:33

VII. Communication Protocol Description

7.1 MODBUS-RTU protocol

7.1.1 MODBUS-RTU communication protocol, adopts RS485 half-duplex communication to check 16-bit CRC. The meter does not return the check error.

- All RS485 loop communication should follow master and slave mode. In this way, information and data are transferred between a single master station and up to 32
- The master station will initialize and control all the information transmitted on the RS485 communication loop (daisy chain);
- In any case, communication cannot be started from a slave station
- Communication on all RS485 loops takes place in a "packaged" manner. A data packet is a communication frame. A packet can contain up to 128 bytes.
- The master station sends called request and the slave sends called response. ;
- In any case, the slave can only respond to one request from the master station;

7.1.2 Data Format

Start Bit	Data Bit	Checking Bit	Stop Bit
1	8	None, Even, Odd checking(Programmable)	1

7.1.3 Communication frame format

Frame Content	Bytes	Instructions
Slave Station Add	1	Valid slave address range is 1-247
Function Code	1	0X03 Read one or more current register values
		0X06 Writes the specified value to an internal register
		0X10 Writes the specified value to multiple internal registers
Data Add	2	The location where the data area is stored when the slave executes a valid command. Different variables occupy different number of registers, some address variables occupy two registers, 4 bytes of data, some variables occupy a register, 2 bytes of data, please use according to the actual situation
Data length	2	The length of data that needs to be read or written
Data	Variable	Slave station returns data or master data to be written
CRC Check Code	2	The MODBUS-RTU mode uses 16-bit CRC. The sending device shall calculate CRC16 on each data in the parcel, and the final result shall be stored in the test domain. The receiving device shall also calculate CRC16 on each data (other than the check field) in the parcel and compare the result field check fields. Only the same package can be accepted.

7.1.4 Communication exception handling

If the master sends an illegal packet or if the master requests an invalid data register, an abnormal data response will be generated. This abnormal data response consists of the slave address, function code, fault code, and check field. When the high-order bit position of the function code domain is 1, it indicates that the data frame at this time is an abnormal response.

According to MODBUS communication requirements, abnormal response function code = request function code + 0x80; when abnormal response occurs, the highest position of function number is 1. For example, if the host request function number is 0x04, the function number returned from the slave corresponds to 0x84.

The following chart shows the meaning of exception error codes:

Error code	Name	Description
0X01	Function code error	The meter received an unsupported function number
0X02	Variable address error	The host specified data location is over the range of the meter or an illegal register operation has been received
0X03	The limit of the data value	The data value sent by the host exceeds the data range corresponding to the instrument or the data structure is incomplete
0X04	Incorrect or out of frame length	The function code and the communication frame length are inconsistent or request exceeds the limit

7.1.5 Communication frame delay

There should be an appropriate delay between the requests from the master station for the two frames. When the baud rate is 9600. In order to ensure a correct response, it is recommended that a 300ms delay be reserved between the two frames. When the baud rate decreases, the communication delay should increase appropriately.

7.2 Communication frame format description

7.2.1 Function Code"03":Read multiple register input

Eg: The host reads the UA (A phase voltage), and it is measured that the A phase voltage is 220.0V. The UA's address code is 0x4000 because UA is a fixed-point number (4 bytes) and occupies 2 data registers. The corresponding hexadecimal data of 220.0V is: 0x0000898 (200)

Host sent message format: (default high word first)

Hosting Sending	Bytes	Information Send	Remark
Slave address	1	01	Send to slave at address 01
Function Code	1	03	Read register
Start Add	2	0x4000	Start Add
Data Length	2	0x0002	Read 2 registers (4 bytes in total)
CRC Code	2	0xD1CB	The host calculates the CRC code

Return message format from slave response :

Slave response	Bytes	Returned information	Remark
Slave address	1	01	From slave 01
Function code	1	03	Read register
Reading	1	04	2 registers total 4 bytes
Register data	1	0x00	High byte of contents at address 0x4000 memory
	1	0x00	High byte of contents at address 0x4000 memory
	1	0x08	Low byte of contents at address 0x4000 memory
	1	0x98	Low byte of contents at address 0x4000 memory
CRC code	2	0xFC59	The CRC code calculated by the host

7.2.2 function code “06”: writing single register

eg:Host writes fixed-point number 1st alarm mode AD1. Assume that the address code of AD1 is 0x4900 because AD1 is a fixed-point number and occupies 1 data register, and decimal 11 corresponds to 0x000B.

Packet format sent by the host:

Host sending	Bytes	Send Message	Example
Slave address	1	01	Sending to slave 01
Function code	1	06	Writing single register
Initial address	1	0x49	The high byte of the address of the register to be written
Write data	1	0x00	The low byte of the address of the register to be written
	1	0x00	High byte of data
Write data	1	0x0B	Low byte of data
	1	0x0B	Low byte of data
CRC code	2	0xDE51	The CRC code calculated by the host

Return message format from slave response :

Host sending	Bytes	Send Message	Example
Slave address	1	01	Sending to slave 01
Function code	1	06	Writing multiple register
Initial address	1	0x49	The high byte of the starting address of the register to be written
	1	0x00	The low byte of the starting address of the register to be written
Write data	1	0x00	High byte of data
	1	0x0B	Low byte of data
CRC code	2	0xDE51	The CRC code calculated by the host

7.2.3 function code “10”: write multiple register

eg:Host writes fixed-point number 1st alarm mode AD1. Assume that the address code of AD1 is 0x4900 because AD1 is a fixed-point number and occupies 1 data register, and decimal 11 corresponds to 0x000B.

Packet format sent by the host:

Host sending	Bytes	Send Message	Example
Slave address	1	01	Sending to slave 01
Function code	1	10	Writing multiple register
Initial address	1	0x49	The high byte of the starting address of the register to be written
	1	0x00	The low byte of the starting address of the register to be written
Data word length to be written	1	0x00	The word length of the write data is high byte
	1	0x01	The word length of the write data is low byte
To write data bytes long	1	0x02	The byte length of data (1 byte in total)
Write data	1	0x00	High byte of data
	1	0x0B	Low byte of data
CRC Code	2	0x3F53	The CRC code calculated by the host

The format of the message returned from the slave response correctly

Slave response	Bytes	Send Message	Example
Slave address	1	01	From slave 01
Function code	1	10	Writing multiple register
Initial address	2	0x4900	Starting address is 0000
Save data word length	2	0x0002	Save 2 words of data
CRC Code	2	0x1795	The CRC code calculated by the host

7.2.4 CRC code calculation method

- 1.Preset a 16-bit register to hexadecimal FFFF (that is all 1); call this register CRC register ;
- 2.Compare the first 8-bit binary data (the first byte of the communication message frame) with the lower 8 bits of the 16-bit CRC register and place the result in the CRC register.
- 3.Move the contents of the CRC register one bit to the right (towards the lower bit) to fill in the highest bit with 0 and check the shifted-out bit after the right shift;
- 4.If the shift-out bit is 0: repeat step 3 (right shift one bit again); if the shift-out bit is 1: CRC register and polynomial A001 (1010 0000 0000 0001) XOR;
- 5.Repeat steps 3 and 4 until right shift 8 times so that the entire 8-bit data is all processed ;
- 6.Repeat Step 2 to Step 5 to process the next byte of the communication message frame.
- 7.After all the bytes of the communication information frame are calculated according to the above steps, the high and low bytes of the obtained 16-bit CRC register are exchanged;
- 8.The final CRC register content is: CRC code.

Attached: CRC calculation C language source code

```

unsigned int GET_CRC(unsigned char * buf,unsigned charnum)
{
    unsigned char i,j;
    unsigned int WCRCL=0xffff;
    for(i=0;i<num;i++)
    {
        WCRCL ^= (unsigned int)(buf[i]); // Cyclic redundancy check
        for(j=0;j<8;j++)
        {
            if(WCRCL&1)
            {
                WCRCL >>= 1;
                WCRCL ^= 0XA001;
            }
            else
            {
                WCRCL >>= 1;
            }
        }
    }
    return(WCRCL); // Get CRC check code
}

```

7.3 Power meter communication address mapping

Instantaneous electrical parameter communication address						
1	0x4000	Phase voltage A	2	long	R	0.1V
2	0x4002	Phase voltage B	2	long	R	
3	0x4004	Phase voltage C	2	long	R	
4	0x4006	Wire voltage AB	2	long	R	
5	0x4008	Wire voltage BC	2	long	R	0.001A
6	0x400a	Wire voltage CA	2	long	R	
7	0x400c	Phase current A	2	long	R	
8	0x400e	Phase current B	2	long	R	
9	0x4010	Phase current C	2	long	R	0.1W
10	0x4012	Active power A	2	long	R	
11	0x4014	Active power B	2	long	R	
12	0x4016	Active power C	2	long	R	
13	0x4018	Total active power	2	long	R	0.1var
14	0x401a	Reactive power A	2	long	R	
15	0x401c	Reactive power B	2	long	R	
16	0x401e	Reactive power C	2	long	R	
17	0x4020	Total reactive power	2	long	R	0.1VA
18	0x4022	Apparent power A	2	long	R	
19	0x4024	Apparent power B	2	long	R	
20	0x4026	Apparent power C	2	long	R	
21	0x4028	Total apparent power	2	long	R	0.001
22	0x402a	Power factor A	2	long	R	
23	0x402c	Power factor B	2	long	R	
24	0x402e	Power factor C	2	long	R	
25	0x4030	Total power factor	2	long	R	0.01Hz
26	0x4032	Frequency	2	long	R	
27	0x4034	Active power	2	long	R	0.001kWh

28	0x4036	Reactive power	2	long	R	0.001kvarh
29	0x4038	Positive active power	2	long	R	0.001kWh
30	0x403a	Negative active power	2	long	R	
31	0x403c	Positive reactive power	2	long	R	0.001kvarh
32	0x403e	Negative reactive power	2	long	R	
33	0x4046	Current active power demand	2	long	R	0.1W
34	0x4048	Maximum active power demand	2	long	R	
35	0x404a	Current reactive power demand	2	long	R	0.1kvar
36	0x404c	Maximum reactive power demand	2	long	R	
37	0x4052	A phase voltage total harmonic content	2	long	R	0.1%
38	0x4054	B phase voltage total harmonic content	2	long	R	
39	0x4056	C phase voltage total harmonic content	2	long	R	
40	0x4058	A phase current total harmonic content	2	long	R	
41	0x405a	B phase current total harmonic content	2	long	R	
42	0x405c	C phase current total harmonic content	2	long	R	
43	0x405e	0 phase current	2	long	R	0.001A
44	0x4060	Phase voltage maximum	2	long	R	0.1V
45	0x4062	Wires voltage maximum	2	long	R	
46	0x4064	Current maximum	2	long	R	0.001A
47	0x4066	Voltage imbalance	2	long	R	0.1%
48	0x4068	Current imbalance	2	long	R	
49	0x406a	A, B phase voltage angle	2	long	R	1°
50	0x406c	B, C phase voltage angle	2	long	R	
51	0x406e	C, A phase voltage angle	2	long	R	
52	0x4070	First quadrant reactive energy	2	long	R	0.001kvarh
53	0x4072	Second quadrant reactive energy	2	long	R	
54	0x4074	Third quadrant reactive energy	2	long	R	
55	0x4076	Fourth quadrant reactive power	2	long	R	
Multi-rate energy communication address						
1	0x4100	Total cumulative total active energy	2	long	R	0.001kWh
2	0x4102	Total cumulative sharp active energy	2	long	R	
3	0x4104	Total cumulative peak active energy	2	long	R	
4	0x4106	Total cumulative flat active energy	2	long	R	
5	0x4108	Total cumulative valley active energy	2	long	R	
6	0x410a	Cumulative total active energy this month	2	long	R	
7	0x410c	Cumulative total sharp active energy this month	2	long	R	
8	0x410e	Cumulative total peak active energy this month	2	long	R	
9	0x4110	Cumulative total flat active energy this month	2	long	R	
10	0x4112	Cumulative total valley active energy this month	2	long	R	
11	0x4114	Cumulative total active energy last month	2	long	R	
12	0x4116	Cumulative total sharp active energy last month	2	long	R	
13	0x4118	Cumulative total peak active energy last month	2	long	R	
14	0x411a	Cumulative total flat active energy last month	2	long	R	
15	0x411c	Cumulative total valley active energy last month	2	long	R	
16	0x411e	Cumulative total active energy last two months	2	long	R	
17	0x4120	Cumulative total sharp active energy last two months	2	long	R	
18	0x4122	Cumulative total peak active energy last two months	2	long	R	
19	0x4124	Cumulative total flat active energy last two months	2	long	R	
20	0x4126	Cumulative total valley active energy last two months	2	long	R	

Fractional harmonic communication address						
1	0x4200	A phase voltage 0th harmonic	1	Int	R	0.01%
2	0x4220	A phase current 0th harmonic	1	Int	R	
Reserved Expansion						
1	0x4300	B phase voltage 0th harmonic	1	Int	R	0.01%
2	0x4320	B phase current 0th harmonic	1	Int	R	
Reserved Expansion						
1	0x4400	C phase current 0th harmonic	1	Int	R	0.01%
2	0x4420	C phase current 0th harmonic	1	Int	R	
Event record communication address						
1	0x4500	Latest event type	1	short	R	
2	0x4501	the latest event occurred time	1	short	R	Year
3	0x4502		1	short	R	Month
4	0x4503		1	short	R	Day
5	0x4504		1	short	R	Hour
6	0x4505		1	short	R	Minute
7	0x4506		1	short	R	Second
..... (30 events in the middle)						
8	0x45d9	32nd event type	1	short	R	
9	0x45da	32nd event occurred time	1	short	R	Year
10	0x45db		1	short	R	Month
11	0x45dc		1	short	R	Day
12	0x45dd		1	short	R	Hour
13	0x45de		1	short	R	Minute
14	0x45df		1	short	R	Second
System Parameter Communication Address						
1	0x4800	Wiring Method(1)	1	int	R/W	
2	0x4801	Voltage transformation ratioPT1	1	int	R/W	0.1
3	0x4802	Voltage transformation ratio PT2	1	int	R/W	0.1
4	0x4803	Current transformation ratioCT1	1	int	R/W	
5	0x4804	Current transformation ratio CT2	1	int	R/W	0.1
6	0x4805	Communication Address 1	1	int	R/W	No decimal point
7	0x4806	Baud Rate 1(attached 2)	1	int	R	
8	0x4807	Data Format 1	1	int	R/W	
9	0x4818	Communication Address 2	1	int	R/W	
10	0x4819	Baud Rate 2(attached 2)	1	int	R	
11	0x480a	Data Format 2	1	int	R/W	
12	0x480b	Switch Output(attached 4)	1	int	R	
13	0x480c	Switch Input(attach5)	1	int	R	
14	0x480d	Remote Control Input(attached 6)	1	int	R/W	
15	0x480f	Backlight time	1	int	R/W	
Alarm parameter communication address						
1	0x4900	1st Alarm Mode	1	int	R/W	
2	0x4901	1st Alarm Unit(attached 3)	1	int	R/W	
3	0x4902	1st Alarm Value	1	int	R/W	0.1
4	0x4903	1st Alarm Backlash	1	int	R/W	0.1
5	0x4904	1st Alarm Output Mode(attached 7)	1	int	R/W	
6	0x4905	1st Action Delay	1	int	R/W	No decimal point
7	0x4906	1st Removal Delay	1	int	R/W	

Transmission parameter address						
1	0x4a00	1st transmission method value	1	int	R/W	No decimal point
2	0x4a01	1st transmission unit(attached 3)	1	int	R/W	
3	0x4a02	1st transmission high limit value	1	int	R/W	
4	0x4a03	1st transmission low limit value	1	int	R/W	
Muti-rates parameter communication address						
1	0x4b00	Period 1 rates	1	int	R/W	0-3
2	0x4b01	Period 2 rates	1	int	R/W	
3	0x4b02	Period 3 rates	1	int	R/W	
4	0x4b03	Period 4 rates	1	int	R/W	
5	0x4b04	Period 5 rates	1	int	R/W	
6	0x4b05	Period 6 rates	1	int	R/W	
7	0x4b06	Period 7 rates	1	int	R/W	
8	0x4b07	Period 8 rates	1	int	R/W	
9	0x4b08	Period 9 rates	1	int	R/W	
10	0x4b09	Period 10 rates	1	int	R/W	
11	0x4b0a	Period 11 rates	1	int	R/W	
12	0x4b0b	Period 12 rates	1	int	R/W	0-95
13	0x4b0c	Time slot 1	1	int	R/W	
14	0x4b0d	Time slot 2	1	int	R/W	
15	0x4b0e	Time slot 3	1	int	R/W	
16	0x4bf	Time slot 4	1	int	R/W	
17	0x4b10	Time slot 5	1	int	R/W	
18	0x4b11	Time slot 6	1	int	R/W	
19	0x4b12	Time slot 7	1	int	R/W	
20	0x4b13	Time slot 8	1	int	R/W	
21	0x4b14	Time slot 9	1	int	R/W	
22	0x4b15	Time slot 10	1	int	R/W	
23	0x4b16	Time slot 11	1	int	R/W	
24	0x4b17	Time slot 12	1	int	R/W	
Reserved Expansion						
System Timing Communication Data						
1	0x4c00	Year	1	int	R/W	0-99
2	0x4c01	Month	1	int	R/W	1-12
3	0x4c02	Day	1	int	R/W	1-31
4	0x4c03	Hour	1	int	R/W	0-23
5	0x4c04	Minute	1	int	R/W	0-59
6	0x4c05	Second	1	int	R/W	0-59
Reserved Expansion						

Attached 1: Wiring instructions

Communication ADD	Value	Display character	Instructions
0X4800	0	3-4	3 phase 4 wires connection
	1	3-3	3 phase 3 wires connection

Attached 2: Communication baud rate

Communication ADD	Value	Display character	Instructions
0X4806	0	4.8k	baud rate 4800bps
	1	9.6k	baud rate 9600bps
	2	19.2k	baud rate 19200bps

Attached 3: Alarm and transmission unit

Communication ADD	Value	Display character	Instructions
0X4901、0X4908 0X4A01、0X4A05	0	1	Unit: 1
	1	K	Unit: K
	2	M	Unit: M

Attached 4: Alarm output status indication

Communication ADD	Bit Number	Alarm loop	Instructions
0X480B	BIT2-BIT15	Unused	Unused
	BIT1	Alarm 2	0: Alarm does not act; 1: Alarm action;
	BIT0	Alarm 1	0: Alarm does not act; 1: Alarm action;

Attached 5: Switch input status indication

Communication ADD	Bit Number	Alarm loop	Instructions
0X480C	BIT4-BIT15	Unused	Unused
	BIT3	Switch input 4	0: disconnect 1: connect
	BIT2	Switch input 3	0: disconnect 1:connect
	BIT4	Switch input 2	0: disconnect 1: connect
	BIT0	Switch input 1	0: disconnect 1: connect

Attached 6: Remote output command description

Communication ADD	Bit number	Alarm loop	Instructions
0X480D	BIT2-BIT15	Unused	Unused
	BIT1	remote control 2	0: disconnect relay; 1: connect relay;
	BIT0	remote control 1	0: disconnect relay; 1: connect relay;

Attached 7: the relay output selection

Communication ADD	Value	Display character	Instructions
0X4904、0X490B	0	RLY1	Select the first relay as output
	1	RLY2	Select the second relay as output

VIII. DLT645 communication description

8.1 Overview

- ① This meter is not designed according to the national grid meter specifications. Therefore, only part of the electrical parameters can be read through the DLT645 protocol. For the specific read parameters, please refer to the correspondence address table below;
- ② The communication data of the national grid is the primary side data without PT and CT. Therefore, in order to prevent the read data from overflowing, the data of this meter read through DLT645 should be the secondary side data;
- ③ For specific DLT645 communication protocol, please refer to "DLT645-2007 Multi-function Energy Meter Communication Protocol"

8.2 DLT645 communication address correspondence table

No.	Parameter	Communication Add	Response bytes	Response qty	Remark
Instantaneous electrical parameters					
1	Phase A voltage	0x02010100	2	1	Instantaneous electrical parameters
2	Phase B voltage	0x02010200	2	1	
3	Phase C voltage	0x02010300	2	1	
4	Voltage data block	0x0201FF00	2	3	
5	Phase A current	0x02020100	3	1	
6	Phase B current	0x02020200	3	1	
7	Phase C current	0x02020300	3	1	
8	Current data block	0x0202FF00	3	3	
9	Combined active power	0x02030000	3	1	
10	Phase A active power	0x02030100	3	1	
11	Phase B active power	0x02030200	3	1	
12	Phase C active power	0x02030300	3	1	
13	Active power data block	0x0203FF00	3	4	
14	Combined reactive power	0x02040000	3	1	
15	Phase A reactive power	0x02040100	3	1	
16	Phase B reactive power	0x02040200	3	1	
17	Phase C reactive power	0x02040300	3	1	
18	Reactive power data block	0x0204FF00	3	4	
19	Combined apparent power	0x02050000	3	1	
20	Phase A apparent power	0x02050100	3	1	
21	Phase B apparent power	0x02050200	3	1	
22	Phase C apparent power	0x02050300	3	1	
23	Apparent power data block	0x0205FF00	3	4	
24	Combined power factor	0x02060000	3	1	
25	Phase A power factor	0x02060100	3	1	
26	Phase B power factor	0x02060200	3	1	
27	Phase C power factor	0x02060300	3	1	
28	Power factor data block	0x0206FF00	3	4	
29	Grid frequency	0x02800002	3	1	
30	Active integrated electric energy	0x00000000	4	1	Cumulative function
31	Positive active integrated electric energy	0x00010000	4	1	
32	Reverse active integrated electric energy	0x00020000	4	1	

Continued from the front chart

Sub-harmonic content rate					
1	1st harmonic of phase A voltage	0x020A0101	2	1	Phase A voltage harmonic data
2				
3	21st harmonic of phase A voltage	0x020A0115	2	1	
4	Phase A voltage harmonic data block	0x020A01FF	2	21	
5	1st harmonic of phase B voltage	0x020A0201	3	1	Phase B voltage harmonic data
6				
7	21st harmonic of phase B voltage	0x020A0215	2	1	
8	Phase B voltage harmonic data block	0x020A02FF	2	21	
9	1st harmonic of phase C voltage	0x020A0301	2	1	Phase C voltage harmonic data
10				
11	21st harmonic of phase C voltage	0x020A0315	2	1	
12	Phase C voltage harmonic data block	0x020A03FF	2	21	
13	1st harmonic of phase A current	0x020B0101	2	1	Phase A current harmonic data
14				
15	21st harmonic of phase A current	0x020B0115	2	1	
16	Phase A current harmonic data block	0x020B01FF	2	21	
17	1st harmonic of phase B current	0x020B0201	2	1	Phase B current harmonic data
18				
19	21st harmonic of phase B current	0x020B0215	2	1	
20	Phase B current harmonic data block	0x020B02FF	2	21	
21	1st harmonic of phase C current	0x020B0301	2	1	Phase C current harmonic data
22				
23	21st harmonic of phase C current	0x0205FF00	2	1	
24	Phase C current harmonic data block	0x020B03FF	2	21	

COMMIX software instructions

1. Configure commix software

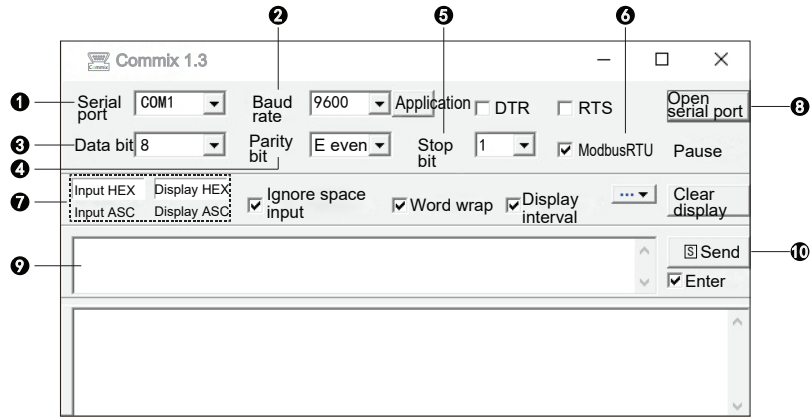

Figure 1

1. Set the serial port to be same as your computer; Example: set it to "COM1" if my computer's serial port is COM1.
2. Configure the baud rate; configure the corresponding baud rate according to the baud rate set by the meter, such as 9600
3. Configure communication data bits; the default is 8 bits.
4. Configure the parity bit; the default is no parity, you can set "even parity" and "odd parity"
5. Configure stop bit; default 1 stop bit
6. Set the data verification mode; set to MODBUS-RTU verification mode, as shown in Figure 2.

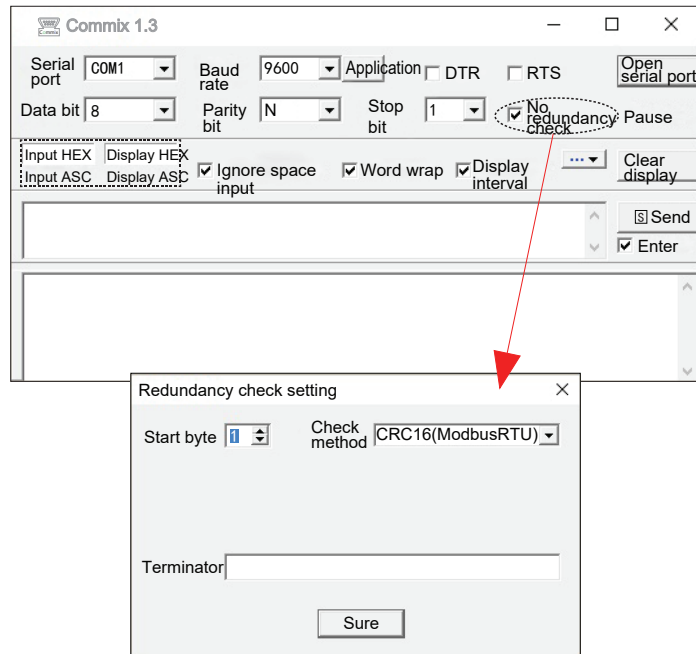

Figure 2

7. Configure the display mode of sending and receiving data; set to "HEX" display mode;
8. After configuring the above functions, open the serial port;
9. Enter the corresponding request message in the sending window, and the CRC will be automatically added;
10. Click Send to display the corresponding data in the receiving window;

II. Send and receive

Send the corresponding request message according to the communication protocol to obtain the corresponding measurement or setting data. If you need to read the phase A voltage, you can use the following message to access, as shown in the figure below.

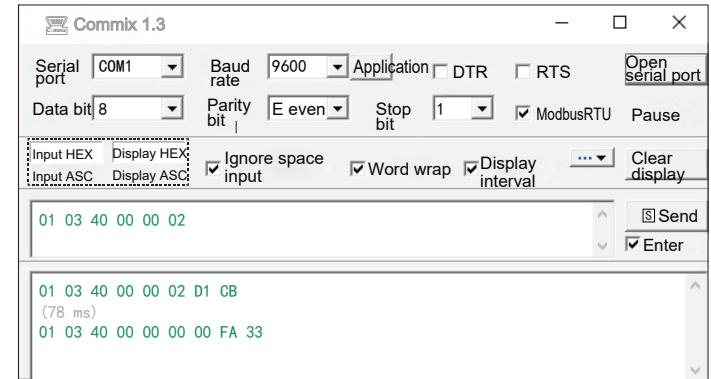

Figure 3

1. Window 1 is the sending message input window; enter the requested message in this window, note that the CRC is automatically added;
2. Window 2 is the message display window; the complete message received and sent is displayed in this window: the green line is the request message sent by the master, and the blue line is the response message returned by the slave.