

DW9L 3Phase Intelligent Power Meter User Manual



MC 00000954

PA 2012E366-44

GB/T 17215 International Standard
GB/T 17626 International Standard

The energy meters are widely applied to control system, SCADA system and energy management system, transformer substation automation, distributing net automation, community electrical power monitor, industrial automation, intelligent construction, intelligent switchboard, switch cabinet, etc. It is easy to install and maintain, simple connection, filed programmable setting input parameters.

Features:
○ Measurement Parameters: 3 phase Voltage/Current/Active power/Reactive power/Frequency/Power factor ect , 28 parameters.
○ Four DI and two DO, isolated input and output.
○ TRMS measure
○ With programmable analog output function , analog output for voltage/current/active power/reactive power/fequency/power factor.
○ With RS485 connection and Modbus RTU communication protocol.
○ With 2 loops active power/reactive power energy pulse output, 2 programmable alarm, display programmable setted parameters.
○ With power failure function for display menu select/KWH/KvarH
○ Optional tariff statistics function.
○ Optional harmonic analysis funtion (including the total harmonic).
○ With zero phase current measure function



Warning: any operation not following the manual will cause accident and damage to the product.

Statement: Information provided in this manual can be modified without prior notice. The company reserves the right of interpretation of the information.

Model Illustration

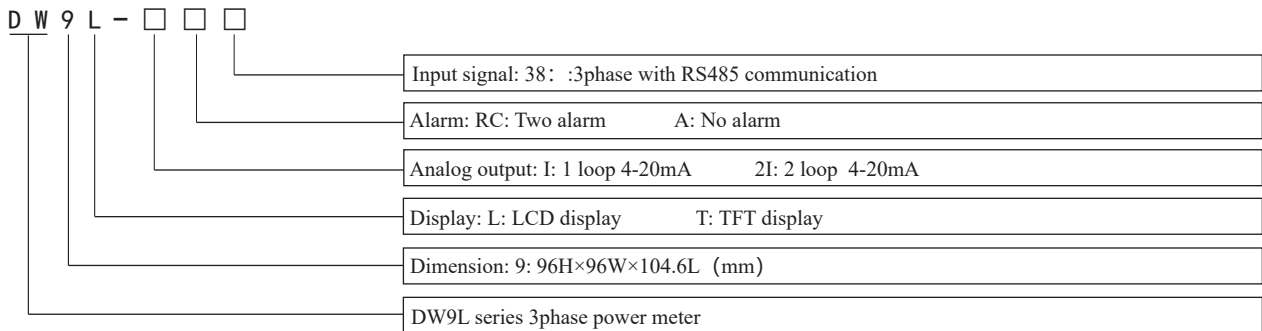

Ordering Information

Model	Alarm	Analog	Communication	Harmonic	Multi-rate
DW9L-RC38	2	No	RS485	Yes	Yes
DW9L-IRC38	2	4-20mA	RS485	Yes	Yes

Specification

Connection	3phase 3wire, 3phase 4wire
Range of Volt meure	AC 3×57.7V/3×220V (NOTE: Voltage direct input: L-N:0 ~ 600V L-L:0 ~ 1000V) Hz
Voltage overload	Continuous: 1.2times Instantaneous: 2times/10S
Voltage condumption	<1VA (each phase)
Voltage impedance	≥300KΩ
Voltage accuracy	RMS measure, Accuracy: 0.5S
Current range	AC 0.025 ~ 5A

Current overload	Continuous: 1.2times Instantaneous: 10times/2S
Current conduction	<0.4VA (each phase)
Current impedance	<20mΩ
Current accuracy	RMS measure, Accuracy: 0.5S
Frequency range	30 ~ 500Hz, Accuracy: 0.1Hz
Power	Active power/ reactive power/ apparent power, accuracy: 0.5S
Energy	Active energy accuracy: 0.5S, reactive energy accuracy: 1S
Display	LCD display (Optional blue backlight or white backlight)
Power supply	AC/DC 100 ~ 240V (85 ~ 265V)
Power consumption	≤7VA
Output digit interface	RS-485 with MODBUS-RTU protocol
Pulse output	2loop energy pulse output(open-collector opto-couple) Normal pulse constant: 9000imp/kWh
DI	4loop DI (dry contact),support remote communication function
Alarm output	2loop DO, 250VAC/3A or 0VDC/5A, support remote control function
Analog output	1loop analog output, 4-20mA(DC) Load < 500Ω
Working environment	Temperature: -10 ~ 50°C; Humidity < 85% RH; No corrosive gas; Altitude≤2500m
Storage environment	-25 ~ 70°C
Isolation withstand voltage	Input signal and power 1600V AC,Input and output 1600VAC,power and analog output, RS485connection, DI connection , Pulse output connection≥DC 2000V
Insulation	Input / output / power supply to meter shell > 5MΩ
Dimension	96W×96H×104.6L (mm)
Weight	0.6kg

■ Panel Indication

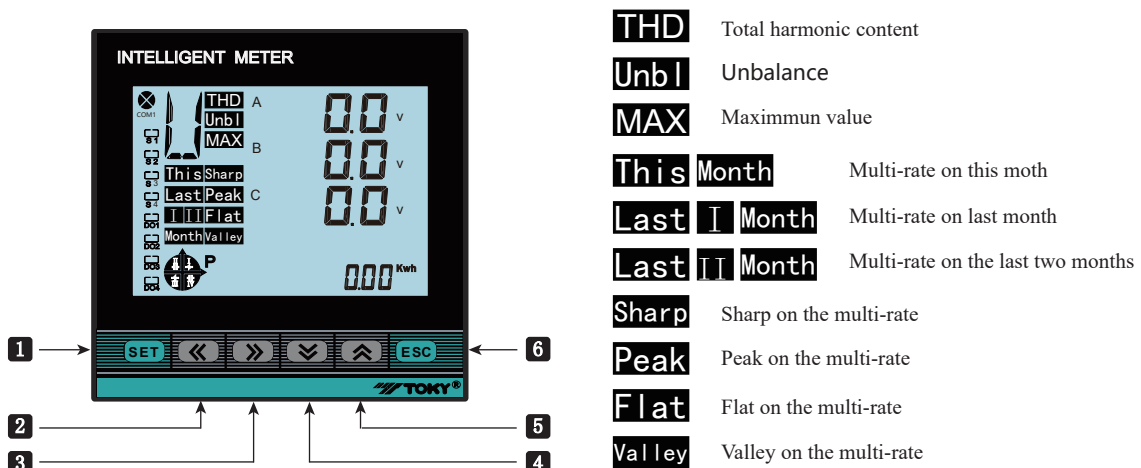

No.	Symbol	Key	Function
1		Enter key	Press this key more than 3 seconds to enter the menu and confirm the set value
2		Left key	In menu operation, it can shift menu and change to display left page
3		Right ket	In menu operation, it can shift menu and change to display right page
4		Decrease key	In menu operation, it is used to enter data setting and decrease value
5		Increase key	In menu operation, it is used to enter data setting and increase value
6		Return key	In menu operation, it is used to return to previous menu

Check measuring value and working status indication:

1. Under measuring status , press key to shift display of 3 phase voltage, 3 phase linear voltage, 3 phase current, total power, frequency, etc.
2. Press key to shift display of Kwh and KvarH.
3. Under alarm mode , DO1 and DO2 is used as alarm output status indication. Under ON/OFF remote control mode , DO1 and DO2 is used as ON/OFF output status indication.
4. S1, S2, S3, S4 indicate ON/OFF remote control input status.
5. COM flash means communicating.

Switching Operation of Measure Interface:

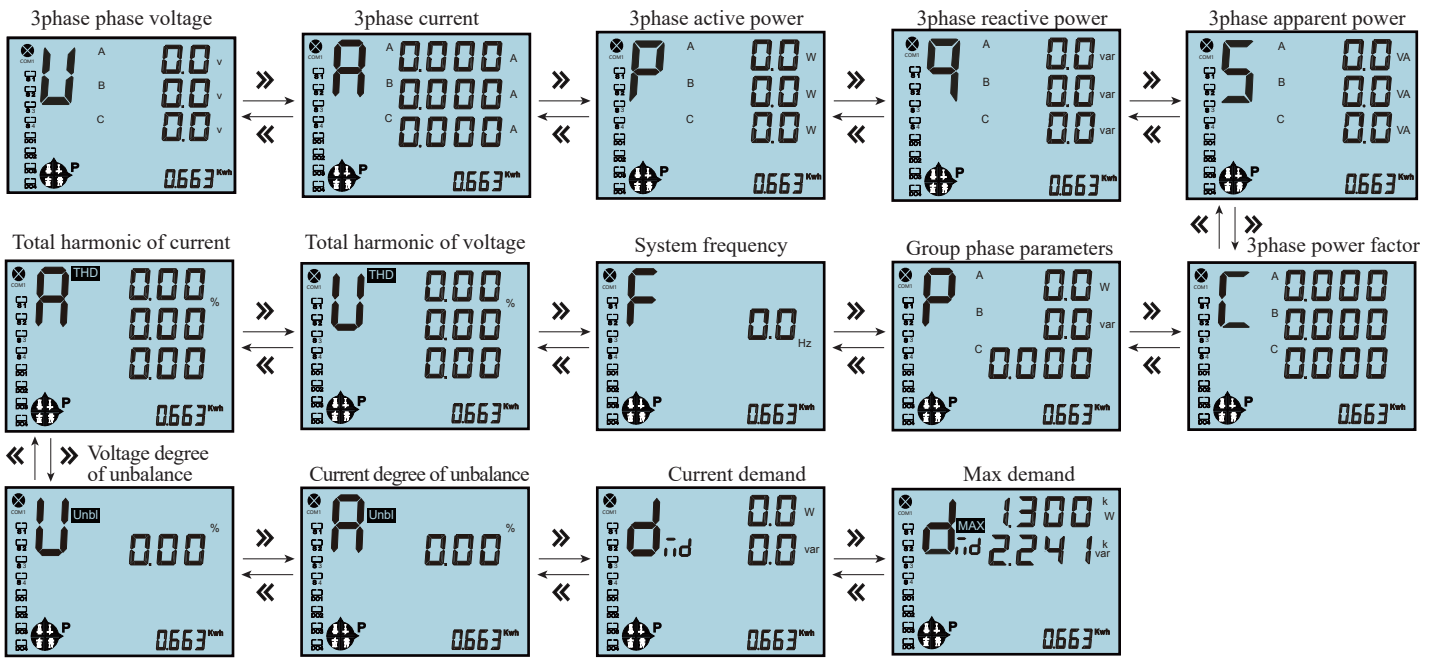

- ① On the 3phase 4wire,press “SET”to switch the display page of line voltage and phase voltage.
- ② On the multi-rate display page,press “ESC”to back to the page.

Switching Operation of Energy Interface:

Refer below operation of “ \blacktriangle ”“ \blacktriangledown ”key switch:

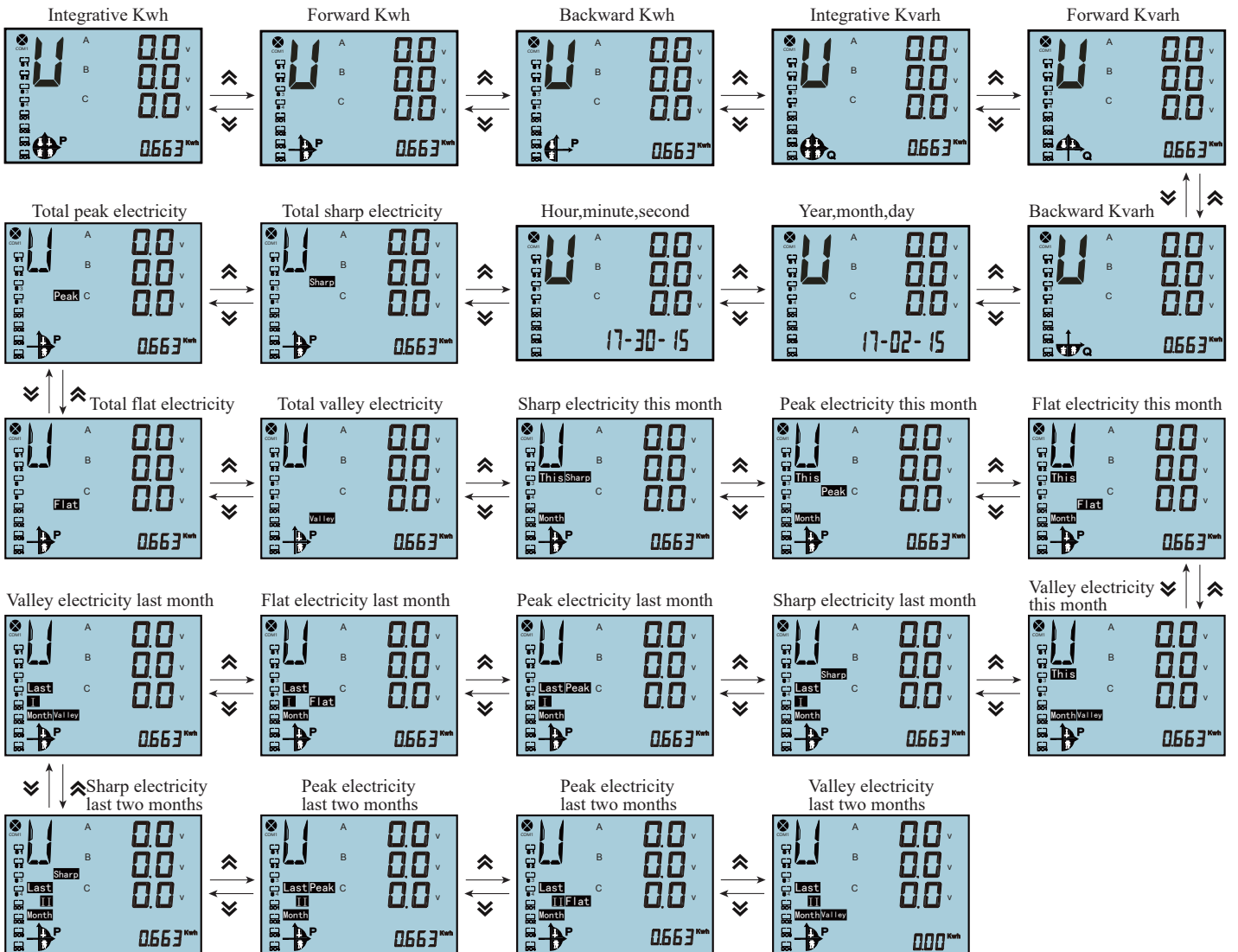

Menu Operation

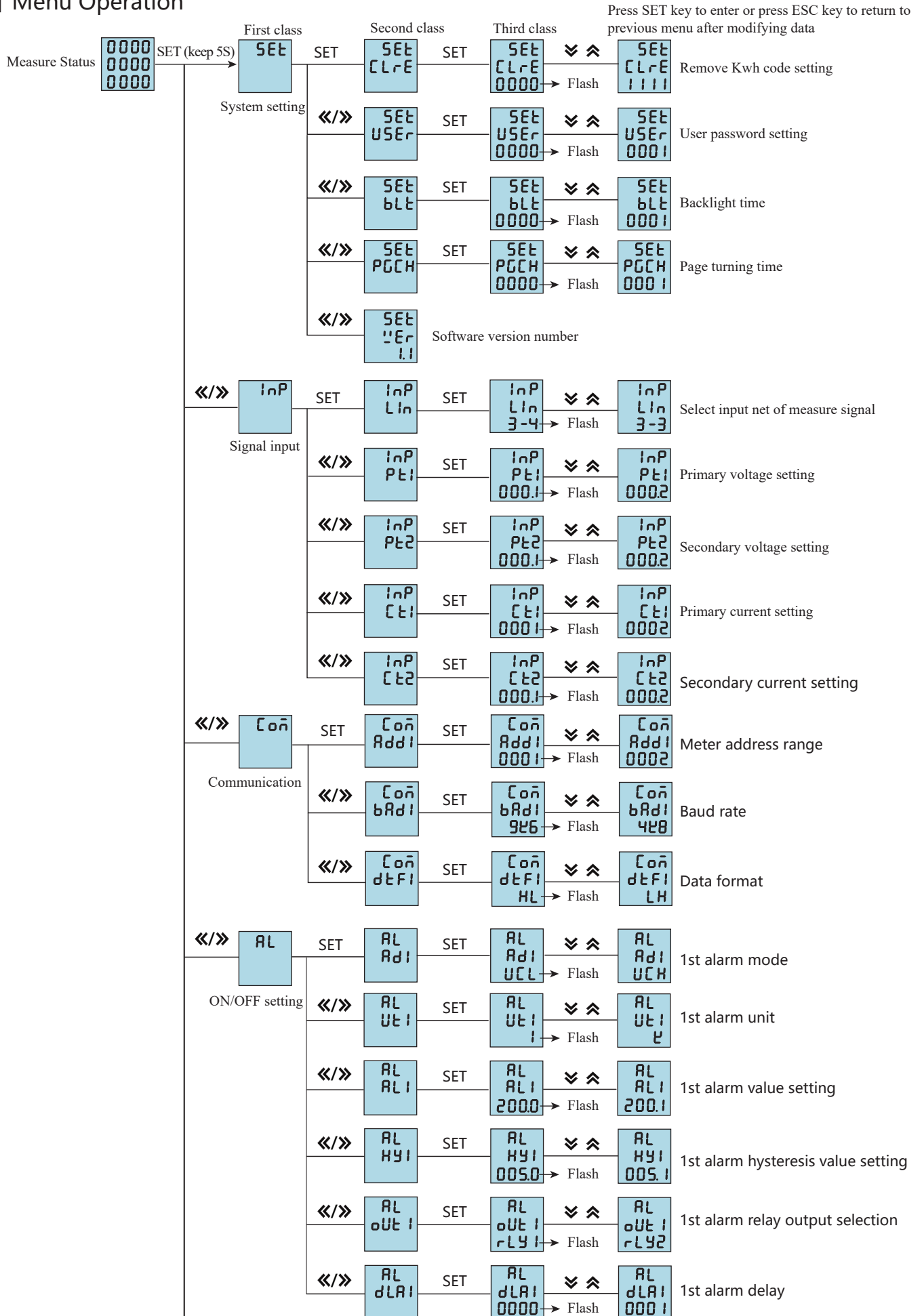

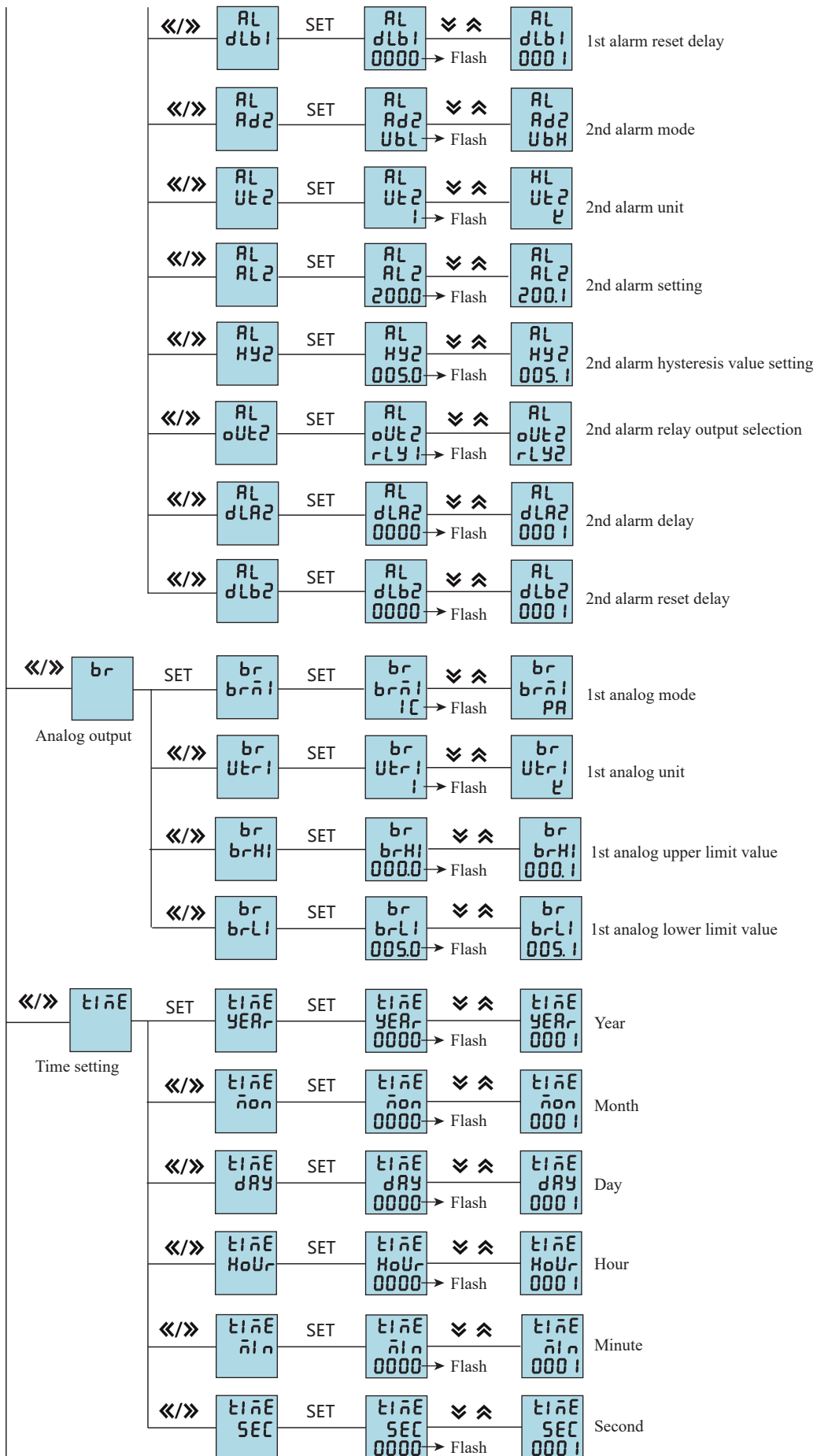

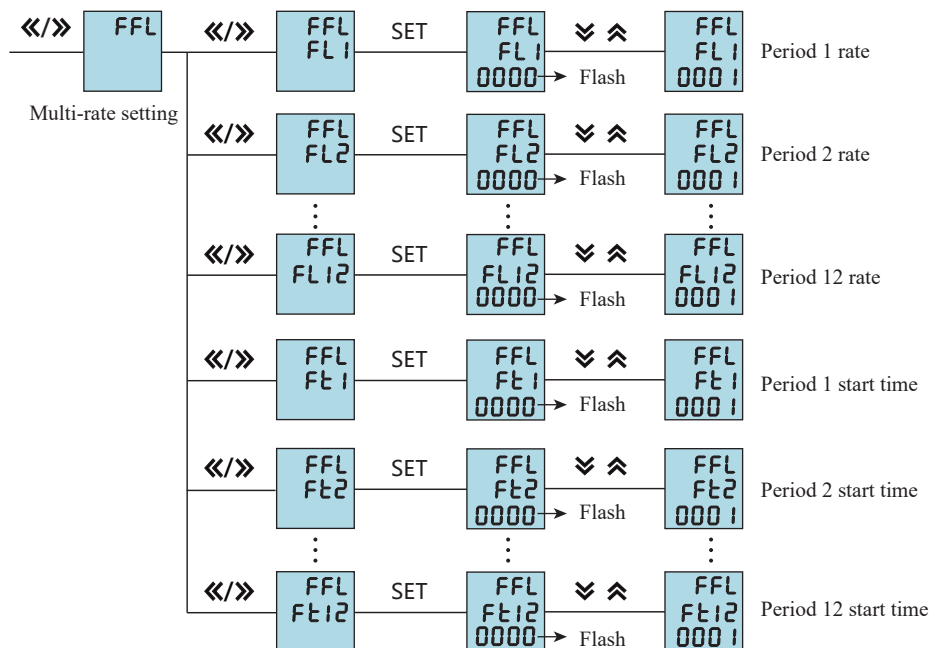

NOTE: The indication of 26 letters in LED:

Letter	A	B	C	D	E	F	G	H	I	J	K	L	M
LED display	A	b	C	d	E	F	9	H	I	J	ℓ	L	ñ
Letter	N	O	P	Q	R	S	T	U	V	W	X	Y	Z
LED display	n	o	P	q	r	S	t	U	v	w	x	y	z

■ Menu Operation Illustration

Under the user menu status:

1. Press "SET" more than 3 seconds. There is a pop-up input frame of password if request here, and then enter the menu to set the parameters.
2. If it is class 1 display, press "SET" to enter next menu, and press " << >> " to change the menu items.
3. If it is class 2 or class 3 display, press "ESC" to return last menu.
4. If it is class 3 display, press " <v> " " <^> " and digit flash, and press " << >> " to shift the digit and Press " <v> " " <^> " to set the value; Press "SET" to save the setting.; If press "ESC" key, it doesn't save the setting and return to class 2 menu.
5. After modification, press "SET" more than 5 second or press "ESC" directly to back to user menu.

Menu Structure and Function Description

No.	Class 1	Class 2	Class 3	Description
1	SEt System setting	Clear nergy	CLrE 0000	Input "1111" to clear energy; Input "2222" to clear max demand; Input "1234" to reset factory default.
		User password	USEr 0000	User password modification
		Backlight time	bLℓ 0000	Time of backlight delay to put out (unit: second). It keeps light if the value is 0.
		Page turning time	PtCH 0000	Time of measure page turning (unit: second). It keeps the same page if the value is 0.
		Software version	VER 1.1	Software version number
2	InP Signal input	Network	Lin 3-3 / 3-4	Select the input net of measure signal
		Voltage ratio	Pt1 1-999.9	Primary voltage, unit: kV
		Voltage ratio	Pt2 10.0-999.9	Secondary voltage, unit: V
		Current ratio	Ct1 1-999.9	Primary current, unit: 1A
		Current ratio	Ct2 10-999.9	Secondary current, unit: 1A
3	Coñ Communication	Address	Add 1 1-247	Meter address range
		Baud rate	bAd 1 4k8 / 9k6	Baud rate: 4k8=4800, 9k6=9600
		Data sequence	dℓF 1 HL / LH	Data sequence: high digit in front or low digit in front

4	AL ON/OFF setting	Alarm mode	Rd1	1-68	When the value is 0, it is for DO1 function, otherwise it is for alarm mode. Please refer to table 1.
		Alarm value unit	Ue1	1/ K/ M	1: means international standard unit; K: means 1000 times of international standard unit; M: means 1000000 times of international standard unit.
		Alarm value	AL1	0-9999.9	1st alarm value setting
		Alarm hysteresis value	HY1	0-9999.9	1st alarm hysteresis value setting
		Alarm relay selection	oUe1	rLY1/rLY2	1st alarm relay output selection
		Alarm delay time	dLA1	0-99	Alarm delay time, unit: second
		Alarm end time	dLb1	0-99	Alarm reset time, unit: second
		Alarm mode	Rd2	1-68	When the value is 0, it is remote control mode, otherwise it is for alarm mode. Please refer to table 1.
		Alarm value unit	Ue2	1/ K/ M	1: means international standard unit, K: means 1000 times of international standard unit, M: means 1000000 times of international standard unit.
		Alarm value	AL2	0-9999.9	2nd alarm value setting
		Alarm hysteresis value	HY2	0-9999.9	2nd alarm hysteresis value setting
		Alarm relay selection	oUe2	rLY1/rLY2	2nd alarm relay output selection
		Alarm delay time	dLA2	0-99	Action delay time (unit: second)
		Alarm end time	dLb2	0-99	Action reset time (unit: second)
5	br Analog output	Analog mode	brā1	1-32	Refer table 1
		Analog unit	Uer1	1/ K/ M	1: means international standard unit, K: means 1000 times of international standard unit, M: means 1000000 times of international standard unit.
		Analog high limit	brH1	0-9999.9	Analog output 20mA
		Analog lower limit	brL1	0-9999.9	Analog output 4mA
6	tiāE Time setting	Year	YEAR	0-99	Year
		Month	āon	1-12	Month
		Day	dAY	1-31	Day
		Hour	HoUr	0-23	Hour
		Minute	āin	0-59	Minute
		Second	SEC	0-59	Second
7	FFL Multi-rate setting	Period 1 rate	FL1	0-3	Period 1 rate, 0, 1, 2, 3 mean sharp, peak, flat, valley rate
		Period 2 rate	FL2	0-3	Period 2 rate, 0, 1, 2, 3 mean sharp, peak, flat, valley rate
		⋮	⋮	⋮	⋮
		Period 12 rate	FL12	0-3	Period 12 rate, 0, 1, 2, 3 mean sharp, peak, flat, valley rate
		Period 1 start time	Ft1	0-95	Period 1 start time NOTE
		Period 2 start time	Ft2	0-95	Period 2 start time NOTE
		⋮	⋮	⋮	⋮
		Period 12 start time	Ft12	0-95	Period 12 start time NOTE

Note Divide 24 hours a day into 96 segments, every 15 minutes as one segments. For example, the corresponding time for segment 0 is 0 o'clock, the corresponding time for segment 10 is two thirty. Please be noticed, from period 1 to period 12, the setting should be raised from small to big.

Corresponding Table of Multi-rate Period				
Hour : Minute	Period		Hour : Minute	Period
0 : 0	0		12 : 0	48
0 : 15	1		12 : 15	49
0 : 30	2		12 : 30	50
0 : 45	3		12 : 45	51
1 : 0	4		13 : 0	52
1 : 15	5		13 : 15	53
1 : 30	6		13 : 30	54
1 : 45	7		13 : 45	55
2 : 0	8		14 : 0	56
2 : 15	9		14 : 15	57
2 : 30	10		14 : 30	58
2 : 45	11		14 : 45	59
3 : 0	12		15 : 0	60
3 : 15	13		15 : 15	61
3 : 30	14		15 : 30	62
3 : 45	15		15 : 45	63
4 : 0	16		16 : 0	64
4 : 15	17		16 : 15	65
4 : 30	18		16 : 30	66
4 : 45	19		16 : 45	67
5 : 0	20		17 : 0	68
5 : 15	21		17 : 15	69
5 : 30	22		17 : 30	70
5 : 45	23		17 : 45	71
6 : 0	24		18 : 0	72
6 : 15	25		18 : 15	73
6 : 30	26		18 : 30	74
6 : 45	27		18 : 45	75
7 : 0	28		19 : 0	76
7 : 15	29		19 : 15	77
7 : 30	30		19 : 30	78
7 : 45	31		19 : 45	79
8 : 0	32		20 : 0	80
8 : 15	33		20 : 15	81
8 : 30	34		20 : 30	82
8 : 45	35		20 : 45	83
9 : 0	36		21 : 0	84
9 : 15	37		21 : 15	85
9 : 30	38		21 : 30	86
9 : 45	39		21 : 45	87
10 : 0	40		22 : 0	88
10 : 15	41		22 : 15	89
10 : 30	42		22 : 30	90
10 : 45	43		22 : 45	91
11 : 0	44		23 : 0	92
11 : 15	45		23 : 15	93
11 : 30	46		23 : 30	94
11 : 45	47		23 : 45	95

For example: Period of sharp,peak,flat and valley in Shenzhen power company.
Peak period: 09:00-11:30,14:00-16:30,19:00-21:00 (total 7hours);
Flat period: 07:00-09:00,11:30-14:00,16:30-19:00,21:00-23:00 (total 9hours);
Valley period: 23:00-morrow 07:00 (total 8hours)

Reference of Meter Setting:

Rate menu	Setting value	Remark	Period menu	Setting value
FL1	2	Flat	FT1	28
FL2	1	Peak	FT2	36
FL3	2	Flat	FT3	46
FL4	1	Peak	FT4	56
FL5	2	Flat	FT5	66
FL6	1	Peak	FT6	76
FL7	2	Flat	FT7	84
FL8	3	Valley	FT8	92
FL9	3	Valley	FT9	92
FL10	3	Valley	FT10	92
FL11	3	Valley	FT11	92
FL12	3	Valley	FT12	92

■ Output Function

1. Energy pulse

DW9L provides the function of energy calculation, with 2 energy pulse output AP & RP, and RS485 interface for the transmit of energy data. The energy pulse of optical couple relay with open collector enables the long distance transmit of active energy AP & reactive energy RP. Remote PC terminal, PLC, DI On-Off output and collector module are applied to collect the pulse of energy meter to enable the energy cumulation calculation. Besides, this output mode is also the energy accuracy check way (National metrology regulations: Standard meter pulse tolerance comparison method)

(1). Electrical characteristic: the output of optical couple relay with open collector , $V \leq 48V$, $I_z \leq 50mA$

(2). Pulse constant: 9000imp/kwh. It means the impulse output No. is 9000 when the energy meter counts up to 1KWH.

The point should be emphasized is that the above 1kwh is for the 2nd coil energy. Supposed that PT and CT is connected , the primary coil energy that 9000 pulse refer to is equal to 1kwhX voltage transform PT X current transform CT.

2. Remote measure and remote control function: 4 loops S1-S4 are used to remote measure electric ON/OFF status. DO1 & DO2 function can be used to remote control electric devices. When using Do function, alarm mode should be setted as 0, otherwise DO1 and DO2 will be as AL1, AL2 output. DO1 DO2 function control value is written via RS485 interface.

3. Communication function (please refer to the communication protocol)

4. Transform output(please refer to table 1)

5. Alarm function (please refer to table 1)

■ Communication Protocol

MODBUS serial communication protocol basic rules:

DW9L series energy meter adopts Modbus RTU communication protocol RS485 half duplex communication , read function code 0x03, write function code 0x10 , adopts 16 digit CRC check, the energy meter does not feedback the check error.

Start bit	Data bit	Stop bit	Check bit
1	8	1	No

(1) All of the RS485 communication should comply with host/slave method. Under this kind of method, information and data is transmitted between one host and maximum 32 slave (monitoring equipment);

(2) Host will initialize and control all information transmitted in RS485 communication circuit.

(3) In any case, communication can never be started from a slave.

(4) All communication is RS485 circuit happen by being packed. One data package is a simple character string (every character string has 8 bit), maximum 128 byte in one package. The byte construction standard of this package is asynchronous serial data, and it is transmitted in 8 data bits, 1 stop bit, no check bit.

(5) Host send is called request, slave send is called response.

(6) In any case, slave can only respond to one request of host.

2. Each MODBUS data package is consisted of five parts as below:

(1) Slave address: address length is 1 byte, effective slave address range is 1-247, if slave receives a frame of data package whose address information is the same as its own address, it will execute the order included in the data package.

(2) Function code length in MODBUS data package is one byte, used to inform the slave what kind of operation needs to be executed. The slave response data package should have the same function code byte of the operation requested by host.

Please refer to below table for related function code:

Function Code	Definition	Function
0x03	Read register	Read one or more current register value
0x06	Write single-register	Write specified value into one internal register
0x10	Write multi-register	Write specified value into several internal registers (Factory default write single register)

(3) Register address variate: the position where the data area is stocked when slave executes effective order. Different variate seizes differents numbers of register, some address variate seizes two register, 4 byte data, some variate seizes one register, 2 byte data, please use according to actual situation.

(4) Data area: data area includes the data needed by terminal to execute specified function or collected data when terminal respond to inquiry. The content of this data could be numerical value, reference address or set value; for example: function code tells terminal to read a register, data area needs to indicate which register to be started from and how many data to be read, embedded address and data will be different according to different content between type and slave; register numerical value sending sequence is: high bit byte in the front, low bit byte in the back.

(5) CRC check: MODBUS-RTU mode adopts 16 bit CRC check. Transmitting equipment should do CRC16 calculation on each data of package, final result is stocked in check area. Receiving equipment also should do CRC16 calculation on each data of package (except check area), and compare result area with check area; only the same package can be accepted, for the specific CRC check algorithm please refer to appendix.

1. Procedure to generate a CRC: (Please refer to below program example)

(1). Preset a 16 digit register as 0FFFFH (all 1), call it CRC register.

(2). Use 8 bit of the first byte of data frame and the low byte of CRC register to do xor operation, result will be stored at CRC register.

(3). Shift CRC register one bit to the right, the highest bit should be filled with 0, and the lowest bit will be shifted out and checked.

(4). If the lowest bit is 0, repeat the 3rd step (next shift); if the lowest bit is 1, use CRC register and a preset fixed value(0A001H) to do the xor operation.

(5). Repeat the 3rd and 4th steps until shift for 8 times. This can finish processing a complete 8 digit.

(6). Repeat 2nd to 5th steps to process the next 8 digit until all bytes are processed.

(7). At last, the value of CRC register is the value of CRC. In addition, there is another way to calculate CRC with the use of preset sheet. Its main feature is fast calculate speed, but the sheet requires bigger storage space, this way will not be illustrated here, please refer to relevant information.

2. Network time consideration

Packet transportation on RS485 network needs to follow below rules about time:

(1) When baud rate is set as 9600, the recommended delay between two host request is 300ms, using a smaller delay may cause package lost.

(2) When use smaller baud rate, please enlarge delay time properly. For example, if baud rate is set as 4800, the delay between two request should be set as 500ms or more.

3. Communication abnormal solution:

If host send a illegal data packet or host request a invalid data register, abnormal data answer will be generated. This abnormal data response consists of slaver address, function code, error code and check code. When function code high bit is 1, it means that the data frame is abnormal response.

Below table illustrates the meaning of abnormal function code:

According to MODBUS communication requirement, abnormal response function code = request function code + 0x80; if abnormal answer, the highest bit of function will be set as 1. For example: if host request function is 0x04, the function code replied from slaver is 0x84.

Error type code	Name	Illustration
0x01	Function code error	Meter does not support the function code it receives
0x02	Variable position error	The data position assigned by host is out of the range of meter, or the meter receives illegal register operation
0x03	Variable data value error	The data value sent from host is out of the range of meter, or incomplete data structure.

4. Communication frame format illustration

(1). Read multi-register

For example: host reads UA (A phase voltage) , if current measured A phase voltage is 220.0V.

UA address code is 0x4000, because UA is fixed point number (4 byte), seizes 2 data register, hexadecimal code of 220.0V is 0x0000898 (2200).

Host request

Slaver address	Read function code	Register address (Variable)		Register number		CRC check code	
1	2	3	4	5	6	7	8
Meter address	Function code	Start address high bit	Start address low bit	High bit	Low bit	CRC code low bit	CRC code high bit
0x01	0x03	0x40	0x00	0x00	0x02	0xD1	0xCB

Slaver normal answer (high bit in the front)

Slaver address	Read function code	Byte number (twice of register number)	Register data		Register data		CRC check code	
1	2	3	4	5	6	7	8	9
Meter address	Function code	Data byte length	Data 1 high bit	Data 1 low bit	Data 2 high bit	Data 2 low bit	CRC code low bit	CRC code high bit
0x01	0x03	0x04	0x00	0x00	0x08	0x98	0xFC	0x59

Slaver normal answer (low bit in the front)

Slaver address	Read function code	Byte number (twice of register number)	Register data		Register data		CRC check code	
1	2	3	4	5	6	7	8	9
Meter address	Function code	Data byte length	Data 2 high bit	Data 2 low bit	Data 1 high bit	Data 1 low bit	CRC code low bit	CRC code high bit
0x01	0x03	0x04	0x08	0x98	0x00	0x00	0x79	0xBC

Function code abnormal answer: (for example, host request function code is 0x04).

Slaver abnormal answer (read multi-register)								
1	2	3	8	9				
Meter address	Function code	Error code	CRC code low bit	CRC code high bit				
0x01	0x84	0x01	0x82	0xC0				

For example: when current measured current value is Ia=100 A, Ib=200 A, Ic=300 A, read three respective current value at the same time. Host send read 01 address meter, read the current value data that starts from 400C (A phase current) register. 100.000 hexadecimal code is 000186A0; 200.000 hexadecimal code is 00030D40; 300.000 hexadecimal code is 000493E0. Data is represented by 32 bit unsigned data, with 3 decimal places.

For example, if data value is 12345, the actual value is 12.345.

Host send

Meter address	Function code	Address		Register number		CRC check code	
01	03	40	0C	00	06	10	0B

Meter reply

Meter address	Function code	Read byte number	Data 1				Data 2				Data 3				CRC check code	
01	03	0C	00	01	86	A0	00	03	0D	40	00	04	93	E0	8F	1D

(2). Write single register

For example: host writes fixed point number of 1st Alarm mode AD1.

If AD1 address code is 0x4900, because AD1 is fixed point number, seizes 1 data register, 11 decimalist code is 0X000B.

Host request (write single register)

Slaver address	Function code	Register address (Variable)		Register data		CRC check code	
1	2	3	4	5	6	7	8
Meter address	Function Code	Start address high 8 bit	Start address low 8 bit	High bit	Low bit	CRC code low bit	CRC code high bit
0x01	0x06	0x49	0x00	0x00	0x0B	0xDE	0x51

Slaver normal answer (write single register)

Slaver address	Function oode	Register address (Variable)		Register data		CRC check code	
1	2	3	4	5	6	7	8
Meter address	Function Code	Start address high 8 bit	Start address low 8 bit	High bit	Low bit	CRC code low bit	CRC code high bit
0x01	0x06	0x49	0x00	0x00	0x0B	0xDE	0x51

(3). Write multi-register

For example: Host write fixed point number of 1st alarm mode AD1.

If AD1 address code is 0x4900, because AD1 is fixed point number, seizes 1 data register, 11 decimalist code is 0X000B.

Host request (write multi-register)										
1	2	3	4	5	6	7	8	9	10	11
Meter address	Function Code	Start address high bit	Start address low bit	Data byte high bit	Data byte low bit	Data byte length	Data 1 high bit	Data 1 low bit	CRC code low bit	CRC code high bit
0x01	0x10	0x49	0x00	0x00	0x01	0x02	0x00	0x0B	0x3F	0x53

Slaver normal answer (write multi-register)							
1	2	3	4	5	6	7	8
Meter address	Function Code	Start address high 8 bit	Start address low 8 bit	Data byte high bit	Data byte low bit	CRC code low bit	CRC code high bit
0x01	0x10	0x49	0x00	0x00	0x01	0x17	0x95

Data position error answer: (eg: host request write address index is 0x0050).

Slaver Abnormal Answer(write multi-register)				
1	2	3	4	5
Meter address	Function Code	Error code	CRC code low bit	CRC code high bit
0x01	0x90	0x02	0xCD	0xC1

DW9L parameter address reflection table

Note: Address code index

No.	Address reflection	Variable name	Byte length	Value range	Read/Write	Remark
1	0x4000	Phase voltage A	2	long	R	0.1V Note ⑦
2	0x4002	Phase voltage B	2	long	R	
3	0x4004	Phase voltage C	2	long	R	
4	0x4006	Line voltage AB	2	long	R	
5	0x4008	Line voltage BC	2	long	R	
6	0x400a	Line voltage CA	2	long	R	
7	0x400c	Phase current A	2	long	R	0.001A Note ⑦
8	0x400e	Phase current B	2	long	R	
9	0x4010	Phase current C	2	long	R	
10	0x4012	Active power A	2	long	R	0.0001KW Note ⑦
11	0x4014	Active power B	2	long	R	
12	0x4016	Active power C	2	long	R	
13	0x4018	Total active power	2	long	R	
14	0x401a	Reactive power A	2	long	R	0.0001Kvar Note ⑦
15	0x401c	Reactive power B	2	long	R	
16	0x401e	Reactive power C	2	long	R	
17	0x4020	Total reactive power	2	long	R	0.0001KVA Note ⑦
18	0x4022	Apparent power A	2	long	R	
19	0x4024	Apparent power B	2	long	R	
20	0x4026	Apparent power C	2	long	R	
21	0x4028	Total apparent power	2	long	R	
22	0x402a	Power factor A	2	long	R	0.001
23	0x402c	Power factor B	2	long	R	
24	0x402e	Power factor C	2	long	R	

25	0x4030	Total power factor	2	long	R	
26	0x4032	Frequency	2	long	R	0.001HZ Note⑦
27	0x4034	Total kWh	2	long	R	0.001kWh Note⑦
28	0x4036	Total kvarh	2	long	R	
29	0x4038	Forward kWh	2	long	R	
30	0x403a	Inverse kWh	2	long	R	
31	0x403c	Forward kvarh	2	long	R	
32	0x403e	Inverse kvarh	2	long	R	
33	0x4046	Current active power demand	2		R	0.001
34	0x4048	Max active power demand	2	long	R	0.001
35	0x404A	Current reactive power demand	2	long	R	
36	0x404C	Max reactive power demand	2	long	R	
37	0x4052	A phase voltage harmonic content	2	long	R	0.1 Note⑦
38	0x4054	B phase voltage harmonic content	2	long	R	
39	0x4056	C phase voltage harmonic content	2	long	R	
40	0x4058	A phase current harmonic content	2	long	R	
41	0x405a	B phase current harmonic content	2	long	R	
42	0x405c	C phase current harmonic content	2	long	R	
43	0x405E	Zero phase current	2	long	R	0.001
Reserve						
44	0x4100	Total Kwh	2	long	R	0.001kWh Note⑦
45	0x4102	Total Sharp Kwh	2	long	R	
46	0x4104	Total Peak Kwh	2	long	R	
47	0x4106	Total flat Kwh	2	long	R	
48	0x4108	Total valley Kwh	2	long	R	
49	0x410a	Total Kwh this month	2	long	R	
50	0x410c	Sharp Kwh this month	2	long	R	
51	0x410e	Peak Kwh this month	2	long	R	
52	0x4110	Flat Kwh thismonth	2	long	R	
53	0x4112	Valley Kwh this month	2	long	R	
54	0x4114	Total Kwh last month	2	long	R	
55	0x4116	Sharp Kwh last month	2	long	R	
56	0x4118	Peak Kwh last month	2	long	R	
57	0x411a	Flat Kwh last month	2	long	R	
58	0x411c	Valley Kwh last month	2	long	R	
59	0x411e	Total Kwh last II month	2	long	R	
60	0x4120	Sharp Kwh last II month	2	long	R	0.001kWh Note⑦
61	0x4122	Peak Kwh last II month	2	long	R	
62	0x4124	Flat Kwh last II month	2	long	R	
63	0x4126	Valley Kwh last II month	2	long	R	
Reserve						
64	0x4800	Voltage ratio PT1	2	long	R/W	0.001 Note⑦
65	0x4802	Voltage ratio PT2	2	long	R/W	
66	0x4804	Current ratio CT1	2	long	R/W	
67	0x4806	Current ratio CT2	2	long	R/W	
68	0x4808	1st Alarm value	2	long	R/W	
69	0x480a	1st Alarm hysteresis value	2	long	R/W	
70	0x480c	2nd Alarm value	2	long	R/W	
71	0x480e	2nd Alarm hysteresis value	2	long	R/W	
72	0x4818	Analog 1 high limit value	2	long	R/W	
73	0x481a	Analog 1 lower limit value	2	long	R/W	

Reserve						
74	0x4900	1st Alarm mode(refer table 1)	1	int	R/W	No decimal point
75	0x4901	1st Alarm unit note④	1	int	R/W	
76	0x4902	1st alarm delay	1	int	R/W	
77	0x4903	1st removal of delay	1	int	R/W	
78	0x4904	2nd Alarm mode(refer table 1)	1	int	R/W	
79	0x4905	2nd Alarm unit note④	1	int	R/W	
80	0x4906	2nd alarm delay	1	int	R/W	
81	0x4907	2nd removal of delay	1	int	R/W	
Reserve						
82	0x4980	1st analog mode (refer table 1)	1	int	R/W	No decimal point
83	0x4981	1st analog unit note④	1	int	R/W	
Reserve						
84	0x4a00	Connection note①	1	int	R	No decimal point
85	0x4a01	Communication add	1	int	R	
86	0x4a02	Baud rate note②	1	int	R	
87	0x4a03	Data format note⑧	1	int	R	
88	0x4a07	DO note③	1	int	R	
89	0x4a08	DI note⑤	1	int	R	
90	0x4a09	Remote control input note⑥	1	int	R/W	
91	0x4a80	Rate 1	1	int	R/W	No decimal point
92	0x4a81	Rate 2	1	int	R/W	
93	0x4a82	Rate 3	1	int	R/W	
94	0x4a83	Rate 4	1	int	R/W	
95	0x4a84	Rate 5	1	int	R/W	
96	0x4a85	Rate 6	1	int	R/W	
97	0x4a86	Rate 7	1	int	R/W	
98	0x4a87	Rate 8	1	int	R/W	
99	0x4a88	Rate 9	1	int	R/W	
100	0x4a89	Rate 10	1	int	R/W	
101	0x4a8a	Rate 11	1	int	R/W	
102	0x4a8b	Rate 12	1	int	R/W	
103	0x4a8c	Period 1 moment	1	int	R/W	
104	0x4a8d	Period 2 moment	1	int	R/W	
105	0x4a8e	Period 3 moment	1	int	R/W	
106	0x4a8f	Period 4 moment	1	int	R/W	
107	0x4a90	Period 5 moment	1	int	R/W	
108	0x4a91	Period 6 moment	1	int	R/W	
109	0x4a92	Period 7 moment	1	int	R/W	
110	0x4a93	Period 8 moment	1	int	R/W	
111	0x4a94	Period 9 moment	1	int	R/W	
112	0x4a95	period 10 moment	1	int	R/W	
113	0x4a96	Period 11 moment	1	int	R/W	
114	0x4a97	Period 12 moment	1	int	R/W	
115	0x4c00	Time of current demand: year	1	int	R	
116	0x4c01	Time of current demand: Month	1	int	R	
117	0x4c02	Time of current demand: Day	1	int	R	
118	0x4c03	Time of current demand: Hour	1	int	R	
119	0x4c04	Time of current demand: Minute	1	int	R	
120	0x4c05	Time of current demand: Second	1	int	R	

121	0x4c06	Time of max active power demand:Year	1	int	R	No decimal point
122	0x4c07	Time of max active power demand:Month	1	int	R	
123	0x4c08	Time of max active power demand:Day	1	int	R	
124	0x4c09	Time of max active power demand:Hour	1	int	R	
125	0x4c0A	Time of max active power demand:Minute	1	int	R	
126	0x4c0B	Time of max active power demand:Second	1	int	R	
127	0x4c0C	Time of max reactive power demand:Year	1	int	R	
128	0x4c0D	Time of max active power demand:Month	1	int	R	
129	0x4c0E	Time of max active power demand:Day	1	int	R	
130	0x4c0F	Time of max active power demand:Hour	1	int	R	
131	0x4c10	Time of max active power demand:Minute	1	int	R	
132	0x4c11	Time of max active power demand:Second	1	int	R	

Reference table 1: Reference table for alarm output and analog output

No.	Parameter	DO code(low alarm)	DO code(high alarm)	Analog output code(4-20mA)
1	Ua(A phase voltage)	1 (UaL)	2 (UaH)	1 (Ua)
2	Ub(B phase volatge)	3 (UbL)	4 (UbH)	2 (Ub)
3	Uc(C phase voltage)	5 (UcL)	6 (UcH)	3 (Uc)
4	U(Phase voltage of A,B,C)	7 (UL)	8 (UH)	4 (NO)
5	Uab(AB line voltage)	9 (UabL)	10 (UabH)	5 (Uab)
6	Ubc(BC line voltage)	11 (UbcL)	12 (UbcH)	6 (Ubc)
7	Uca(CA line voltage)	13 (UcaL)	14 (UcaH)	7 (Uca)
8	UL(Line voltage of AB,BC,CA)	15 (ULL)	16 (ULH)	8 (NO)
9	Ia(A line current)	17 (IaL)	18 (IaH)	9 (Ia)
10	Ib(B line current)	19 (IbL)	20 (IbH)	10 (Ib)
11	Ic(C line current)	21 (IcL)	22 (IcH)	11 (Ic)
12	I(phase current of A,B,C)	23 (IL)	24 (IH)	12 (NO)
13	Pa(A phase active power)	25 (PaL)	26 (PaH)	13 (Pa)
14	Pb(B phase active power)	27 (PbL)	28 (PbH)	14 (Pb)
15	Pc(C phase active power)	29 (PcL)	30 (PcH)	15 (Pc)
16	P(Total active power)	31 (PL)	32 (PH)	16 (PS)
17	Qa(A phase reactive power)	33 (QaL)	34 (QaH)	17 (Qa)
18	Qb(B phase reactive power)	35 (QbL)	36 (QbH)	18 (Qb)
19	Qc(C phase reactive power)	37 (QcL)	38 (QcH)	19 (Qc)
20	Q(Total reactive power)	39 (QL)	40 (QH)	20 (QS)
21	Sa(A phase apparent power)	41 (SaL)	42 (SaH)	21 (Sa)
22	Sb(B phase apparent power)	43 (SbL)	44 (SbH)	22 (Sb)
23	Sc(C phase apparent power)	45 (ScL)	46 (ScH)	23 (Sc)
24	S(Total apparent power)	47 (SL)	48 (SH)	24 (SS)
25	PFa(A phase power factor)	49 (PFaL)	50 (PFaH)	25 (PFa)
26	PFb(B phase power factor)	51 (PFbL)	52 (PFbH)	26 (PFb)
27	PFc(C phase power factor)	53 (PFcL)	54 (PFcH)	27 (PFc)
28	PF(Total power factor)	55 (PFLl)	56 (PFLH)	28 (PFL)
29	F (Frequency)	57 (FL)	58 (FH)	29 (F)
30	EP (Total Kwh)	59 (EPL)	60 (EPH)	30 (EP)
31	EQ (Total Kvarh)	61 (EQL)	62 (EQH)	31 (EQ)
32	Zero line current	63 (InL)	64 (InH)	32 (In)
33	Unbalance	65 (UNNB)	66 (ULNB)	
34	Unbalance	67 (INNB)	68 (PNNB)	

Note①:Connection

Communication	0	1
Menu display	3-4	3-3

Note④:Alarm / analog value unit

Communication	0	1	2
Menu display	1	K	M

Note②:Baud rate

Communication	0	1	2	3	4
Menu display	1.2	2.4	4.8	9.6	19.2

Note③:Indication of measure (DO)

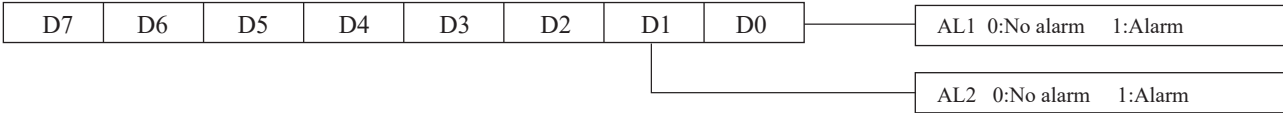

Note⑤:Indication of measure (DI)

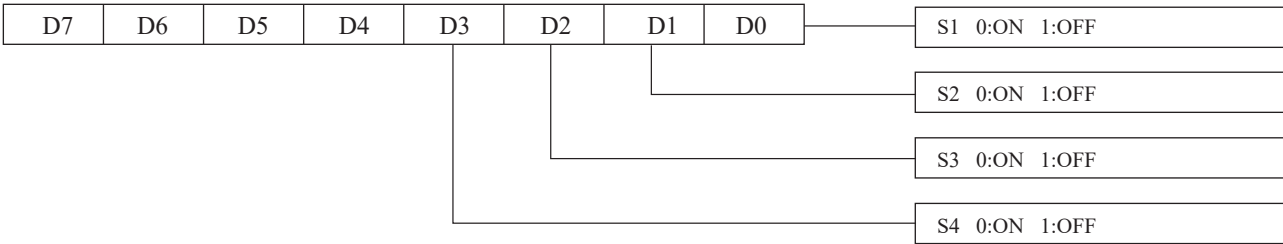

Note⑥:Indication of measure (Remote control, communication write 0x4a09)

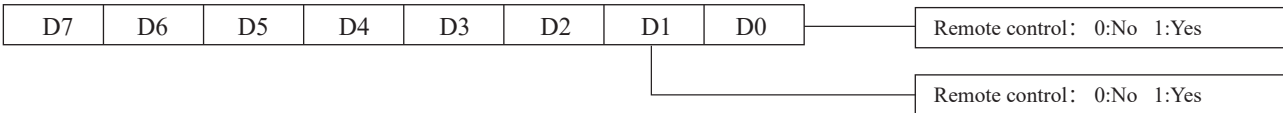

Note⑦:The indication of actual value after communication read:

Communication data adopt hexadecimal format,including 32 bit and 16 bit.
 The actual measure data is reading data multiplied by corresponsive unit.
 For example,RS485 read the data of A phase voltage 0X00038E28,and voltage unit is 0.001V,
 then the actual value is 233000 (0X00038E28) x0.001V=233.0V

Note⑧:Data format

1	0
LH	HL

The program of achieving 16 bit CRC check code

```

unsigned int Get_CRC (uchar*pBuf,uchar num)
{
    unsigned i,j;
    unsigned int wCrc=0xFFFF;
    for(i=0;i < num;i++)
    {
        wCrc^=(unsigned int)(pBuf[i]);
        for(j=0;j < 8;j++)
        {
            if(wCrc & 1){wCrc >>=1; wCrc^=0xA001;}
            else wCrc >>=1;
        }
    }
    return wCrc;
}
    
```

Dimension

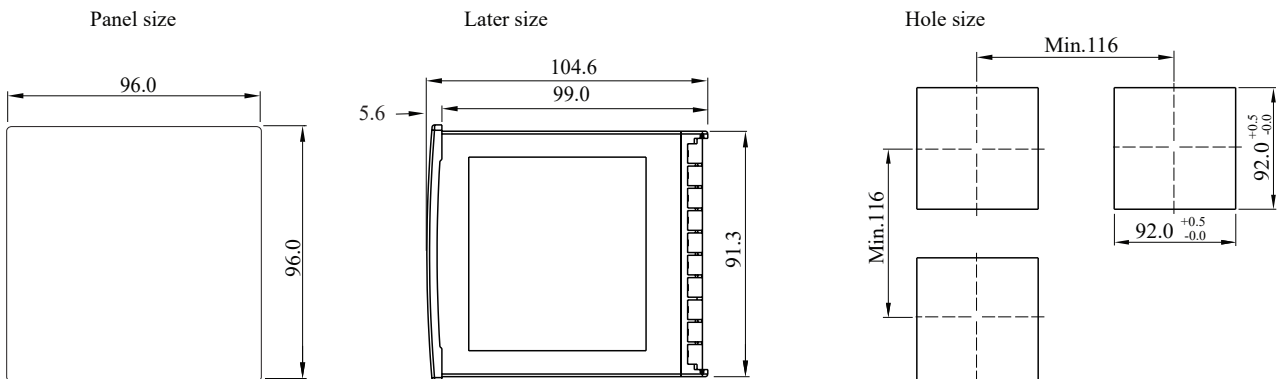

■ Connection

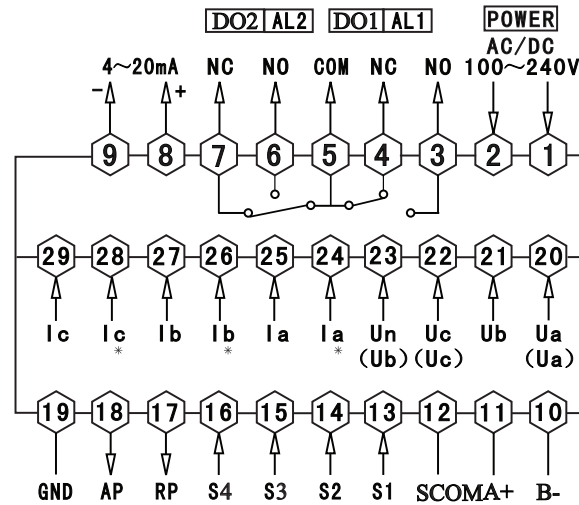

Note: Voltage input connection terminal, bracket terminals shows 3 phase 3 wire connection method, if there is any change, please turn to the correct diagram on the meter.

Mode 1(3 CT):Connection of 3phase 3wire

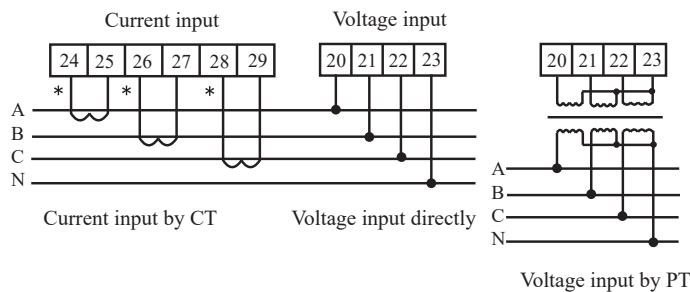

Mode 2(2 CT):Connection of 3phase 3wire

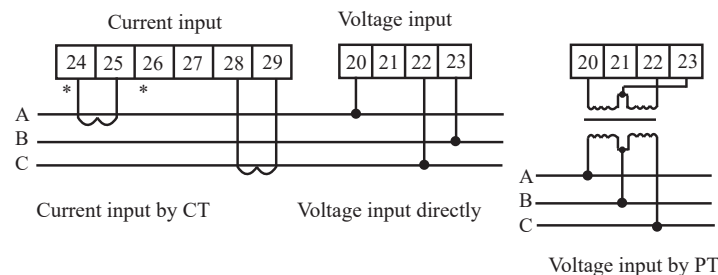

Explanation :

- A. Voltage input: Input voltage should not be higher than the rated input voltage of meter, otherwise a PT should be used.
- B. Current input: Standard rated input current is 5A. A CT should be used when the input current is bigger than 5A. If some other meters are connected with the same CT , the connection should be serial for all meters.
- C. Please make sure that the input voltage is corresponding to the input current, they should have the same phase sequence and direction, otherwise data and sign error may occur (power and energy).
- D. The connection mode of meter which is connected to power network should depend on the CT quantity. For 2pcs of CT, it should be 3 phase 3 wire connection. For 3pcs of CT, it should be 3 phase 4 wire connection.
- E. Please pay high attention on the difference between 3 phase 3 wire and 3 phase 4 wire connection , because wrong connection may lead to incorrect calculation of power factor, power and energy .

Caution:

1. Power supply connection must be correct.
2. Pay attention on the phase sequence of voltage signal input.
3. Current signal input should be connected as per the connection drawing.
4. Connection mode should accord to the setting of user menu link.
5. Energy pulse output is open collector output.
6. Isolation between power supply and circuit board, in case of leakage switch mis-action.