

# Intelligent Temperature Controller

## User Manual

Applicable TEY-A version



### Features

- Optional input signal types and models
- With functions of measurement display, control output, alarm output, analog output, RS485 communication, etc.
- Multi PID control algorithms for option, and with auto-tune function.
- This product is used in industrial machinery, machine tools, general measuring instruments and equipment.

National High-tech Enterprise/ National Standard Drafting Unit  
 Hotline: 400-0760-168 Version code: KKTEY-A01E-A/1-20210510

The instruction explain instrument settings, connections,name and etc, please read carefully before you use the temperature controller. Please keep it properly for necessary reference.

### I. Safe Caution

#### Warning

- When the failure or abnormal of products lead to a system of major accidents, please set the proper protection circuit in the external.
- Please don't plug in before completing all the wire. Otherwise it may lead to electric shock, fire, fault.
- Not allow to use outside the scope of product specification, otherwise it may lead to fire, fault.
- Not allow to use in the place where is inflammable and explosive gas.
- Do not touch power terminal and other high voltage part when the power on, otherwise you may get an electric-shock.
- Do not remove, repair and modify this product, otherwise it may lead to electric shock, fire, fault.

#### Caution

- The product should not be used in a nuclear facility and human life associated medical equipment.
- The product may occur radio interference when it used at home. You should take adequate countermeasures.
- The product get an electric shock protection through reinforced insulation. When the product is embedded in the devices and wiring, please subject to the specification of embedded devices.
- In order to prevent surge occurs, when using this product in the place of over 30m indoor wiring and wiring in outdoor, you need to set the proper surge suppression circuitry.
- The product is produced based on mounting on the disk. In order to avoid to touch the wire connectors, please take the necessary measures on the product.
- Be sure to observe the precautions in this manual, otherwise there is a risk of a major injury or accident.
- When wiring, please observe the local regulation.
- To prevent to damage the machine and prevent to machine failure, the product is connected with power lines or large capacity input and output lines and other methods please install proper capacity fuse or other methods of protection circuit.
- Please don't put metal and wire clastic mixed with this product, otherwise it may lead to electric shock, fire, fault.
- Please tighten screw torque according to the rules. If not, it may lead to electric shock and fire.
- In order not to interfere with this products to dissipate heat, please don't plug casing around the cooling vent hole and equipment.
- Please don't connect any unused terminal.
- Please do the cleaning after power off, and use the dry cleaning cloth to wipe away the dirt. Please don't use desiccant, otherwise, it may casue the deformation or discoloration of the product.
- Please don't knock or rub the panel with rigid thing.
- The readers of this manual should have basic knowledge of electrical, control, computer and communications.
- The illustration, example of data and screen in this manual is convenient to understand, instead of guaranteeing the result of the operation.
- In order to use this product with safety for long-term, regular maintenance is necessary. The life of some parts of the equipments are by some restrictions, but the performance of some will change for using many years.
- Without prior notice, the contents of this manual will be change. We hope these is no any loopholes, if you have questions or objections, please contact us.

### Caution of Install & Connection

- Installation
  - This product is used in the following environmental standards. (IEC61010-1) [Overvoltage category II, class of pollution 2]
  - This product is used in the following scope: environment, temperature, humidity and environmental conditions. Temperature: 0~50°C; humidity: 45~85%RH; Environment condition: Indoor warranty. The altitude is less than 2000m.
  - Please avoid using in the following places:
    - The place will be dew for changing temperature; with corrosive gases and flammable gas; with vibration and impact; with water, oil, chemicals, smoke and steam facilities with Dust, salt, metal powder; and with clutter interference, static electric and magnetic fields, noise; where has air conditioning or heating of air blowing directly to the site; where will be illuminated directly by sunlight; where accumulation of heat will happen caused by radiation.
  - On the occasion of the installation, please consider the following before installation.
    - In order to protect heat saturated, please ensure adequate ventilation space.
    - Please consider connections and environment, and ensure that the products below for more than 50mm space. Please avoid to installed over the machine of the calorific value (Such as heaters, transformer, semiconductor operations, the bulk resistance). When the surrounding is more than 50, please using the force fan or cooling fans. But don't let cold air blowing directly to the product. In order to improve the anti-interference performance and security, please try to stay away from high pressure machines, power machines to install.
    - Don't install on the same plate with high pressure machine and the product.
    - The distance should be more than 200mm between the product and power line.
- Cable caution:
  - Please use specified compensation wire in the place of TC input; Please use insulated TC if the measured device is heated metal.
  - Please use the cable of lesser resistance in the place of RTD input, and the cable (3 wire) must be no resistance difference, but the total length is within 5m.
  - In order to avoid the effect of noise, please put the input signal away from meter cable, power cable, load cable to wiring.
  - In order to reduce the power cables and the load power cables on the effect of this product, please use noise filter in the place where easy to effect. You must install it on the grounding of the disk if you use the noise filter, and make the wiring to be shortest between noise filter output side and power connectors. Don't install fuse and switch on the wiring of noise filter output side, otherwise it will reduce the effect of noise filter.
  - It takes 5s from input power to output. If there is a place with interlocking actions circuit signal, please use timer relay.
  - Please use twisted pair with a shield for analog output line, can also connect the common-mode coil to the front-end of the signal receiving device to suppress line interference if necessary, to ensure the reliability of signal.
  - Please use twisted pair with a shield for remote RS485 communication cable, and deal with the shield on the host side earth, to ensure the reliability of signal.
  - This product don't have the fuse; please set according to rated voltage 250V, rated current 1A if you use; fuse type: relay fuse.
  - Please use suitable slotted screwdriver and wire.

### II. Ordering information

TEY4□□RC18□□A	1 A: Version
	2 Blank: TC/RTD/mV/Rt input X: mA/V input
	10: Single input without RS485
	18: Single input with RS485
	4 B: 1 alarm output C: 2 alarm output
	5 R: Relay output S: SSR output
	D: DC 4~20mA output (can be changed to analog output by ACT menu) K: SCR output (can be ordered) M: SSR or relay (switched by ACT)
	6 Blank: No this function. I: DC 4~20mA analog output (can be switched to control output by ACT menu, available for TE6 & TE9)
	7 Blank: AC/DC 100~240V F: AC/DC 24V
	4: 48H*48W*73L 6: 96H*48W*73L 7: 72H*72W*73L
	8: 96H*48W*73L 9: 96H*96W*73L
	TEY series temperature controller

### III. Models

No.	Model	OUT1 control output		Alarm output		Analog output	Comm.	Auxiliary power
		RELAY	SSR	4~20mA	AL1 OUT2	AL2	4~20mA	RS485
1	TEY4-DC18□							
2	TEY4-DC10□							
3	TEY4-RC18□							
4	TEY4-SC18□							
5	TEY4-MC10□							
6	TEY7-DC18□							
7	TEY7-DC10□							
8	TEY7-MC18□							
9	TEY7-MC10□							
10	TEY6/8/9-IMC18□							
11	TEY6/8/9-IMC10□							
12	TEY6/8/9-DC18□							
13	TEY6/8/9-DC10□							
14	TEY6/8/9-MC18□							
15	TEY6/8/9-MC10□							

□: Blank: input signal is TC/RTD/mV/Rt; "X": input signal is 4~20mA/0~10V  
 ●: Standard configuration function  
 ◎: The meter has this function, but it is combined with another function. This series only have one loop 4~20mA output, but the user can modify menu ACT to use it as main control output or analog output.

### IV. Specifications

Electrical parameters:	
Sample rate	2 times per second
Relay capacity	AC 250V /3A Life of rated load>100,000 times
Power supply	AC/DC 100 ~ 240V (85-265V)
Power consumption	< 10VA
Environment	Indoor use only, temperature: 0~50°C no condensation, humidity < 85%RH, altitude < 2000m
Storage environment	-10 ~ 60°C, no condensation
SSR output	DC 24V pulse voltage, load < 30mA
Current output	DC 4 ~ 20mA load < 500Ω, temperature drift 250PPM
Communication port	RS485 port Modbus-RTU protocol, max input 30 units
Insulation impedance	Input, output, power VS meter cover > 20MΩ
ESD	IEC/EN61000-4-2 Contact ±4KV /Air ±8KV perf.Criteria B
Pulse traip anti-interference	IEC/EN61000-4-4 ±2KV perf.Criteria B

Surge immunity	IEC/EN61000-4-5 ±2KV perf.Criteria B
Voltage drop & short interruption immunity	IEC/EN61000-4-29 0% ~ 70% perf.Criteria B
Isolation voltage	Signal input, output, power: 1500VAC 1min, <60V low voltage circuit: DC500V, 1min
Total weight	About 400g
Cover material	The shell and panel frame PC/ABS (Flame Class UL94V-0)
Panel material	PC
Power failure memory	10 years, times of writing: 1 million times
Safety Standard	IEC61010-1 Overvoltage category II, pollution level 2, level II (Enhanced insulation)

### 2. Measured signal specifications:

Input type	Symbol	Measure range	Resolution	Accuracy	Input impedance /auxiliary current	Comm. parm. code
K1	℄	-50 ~ 1200	1°C	0.5%F.S.±3digits	>500KΩ	0
K2	℄	-50.0 ~ 999.9	0.2°C	0.5%F.S.±1°C	>500KΩ	16
J1	℄	0 ~ 1200	1°C	0.5%F.S.±3digits	>500KΩ	1
J2	℄	0.0 ~ 999.9	0.2°C	0.5%F.S.±1°C	>500KΩ	17
E1	℄	0 ~ 850	1°C	0.5%F.S.±3digits	>500KΩ	2
E2	℄	0.0 ~ 850.0	0.3°C	0.5%F.S.±1°C	>500KΩ	18
T1	℄	-50 ~ 400	1°C	0.8%F.S.±3°C	>500KΩ	3
T2	℄	-50.0 ~ 400.0	0.4°C	0.8%F.S.±3°C	>500KΩ	19
B	b	250 ~ 1800	1°C	1%F.S.±2°C	>500KΩ	4
R	r	-10 ~ 1700	1°C	1%F.S.±2°C	>500KΩ	5
S	s	-10 ~ 1600	1°C	1%F.S.±2°C	>500KΩ	6
N1	n	-50 ~ 1200	1°C	0.8%F.S.±1°C	>500KΩ	7
N2	n	-50.0 ~ 999.9	0.2°C	0.8%F.S.±1°C	>500KΩ	20
PT100-1	℄	-200.0 ~ 600.0	0.2°C	0.5%F.S.±0.3°C	0.2mA	8
PT100-2	℄	-200 ~ 600	1°C	0.5%F.S.±3digits	0.2mA	21
JPT100-1	℄	-200.0 ~ 500.0	0.2°C	0.5%F.S.±0.3°C	0.2mA	9
JPT100-2	℄	-200 ~ 500	1°C	0.5%F.S.±3digits	0.2mA	22
CU50-1	℄	-50.0 ~ 150.0	0.2°C	0.5%F.S.±3°C	0.2mA	10
CU50-2	℄	-50 ~ 150	1°C	0.5%F.S.±3°C	0.2mA	23
CU100-1	℄	-50.0 ~ 150.0	0.2°C	0.5%F.S.±1°C	0.2mA	11
CU100-2	℄	-50 ~ 150	1°C	0.5%F.S.±3digits	0.2mA	24
0 ~ 50mV	℄	-1999 ~ 9999	12bit	0.5%F.S.±3digits	>500KΩ	12
0 ~ 400K	℄	-1999 ~ 9999	12bit	0.5%F.S.±3digits	>500KΩ	13
* 4 ~ 20mA	℄	-1999 ~ 9999	12bit	0.5%F.S.±3digits	<50Ω	14
* 0 ~ 10V	℄	-1999 ~ 9999	12bit	0.5%F.S.±3digits	>1MΩ	15

\*: Please indicate the requirement when choose the model.

### 3. Isolation diagram:

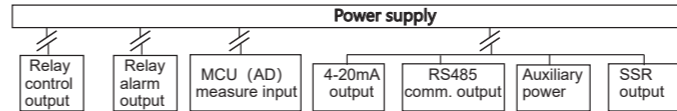

Note: when the auxiliary power is used as power supply for external sensor, if the sensor is non-isolated, then there is no isolation between input and 4-20mA output, nor between input and RS485 comm.. If 4-20mA output coexists with RS485 comm., there is no isolation between them.

### V. Dimension and installation size

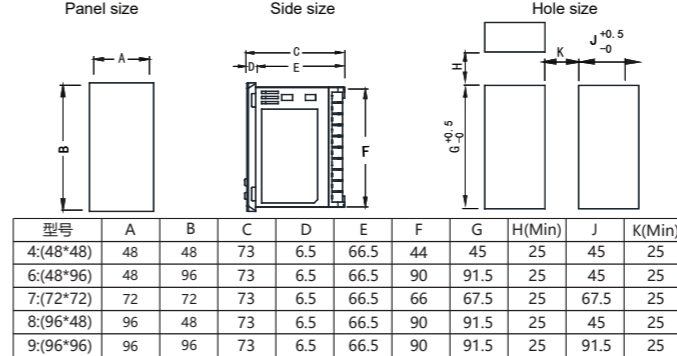

### VI. Connections

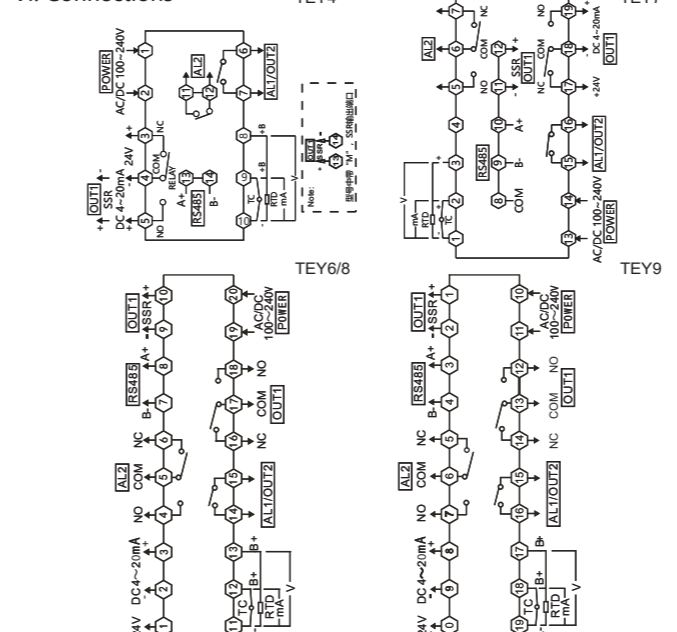

### Connection diagram symbols and function description

Type	Symbol	Illustration	Function
Input	TC	Thermocouple	Thermocouple input connection, distinguish positive and negative. Support K, J, E, T, N, R, S, B type, switched by INP menu.
Input	RTD	Thermal resistance	Thermal resistance input, normally 3 wires, +B and +B are the same color wire or short circuit wire, -A and B connect to thermal resistance. For 2 wires RTD, B and B need to be short circuited. Support PT100, CU100, CU50 etc, switched by INP menu.
Input	mA	Analog signal	4-20mA input (this function can be customized)
Input	V	Analog signal	0-10V/0-5V input (this function can be customized)
Communication	RS485	A+Send B-Receive	RS485 communication port, COM is connected to shield wire, A+ send, B- receive
Alarm 1 / control output 2	AL1/ OUT2	COM common port	When it is used as Alarm 1, please adjust the parameters AL1, AD1 and HY1. When it is used as OUT 2 cooling output, please set OT as PID heating-cooling control, AL1 does not work when it is user as OUT2, and related menus for AL1 are hidden.
		NO	
Alarm 2	AL2	COM common port NO NC	Alarm 2, need to adjust AL2, AD2, HY2 parameters.
Relay output	OUT1 RELAY	COM common port NO NC	OUT1 is the relay control output terminal, which is set by OT and ACT menu. COM common port, NO, NC.
SSR output	OUT1 SSR	+ Positive - Negative	OUT1 is the SSR control output terminal, which is set by OT and ACT menu.
4-20mA Output	4-20mA	+ Positive - Negative	OUT1 is the analog output or current control output terminal, which is set by OT and ACT menu
Auxiliary power supply	DC 24V	+ Positive - Negative	Output power for sensor.

### VII. Panel Illustration

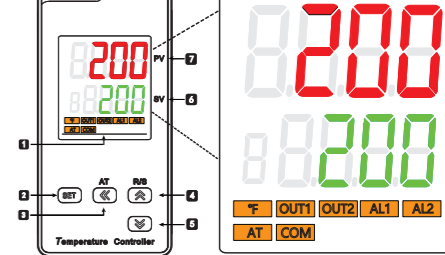

No.	Symbol	Name	Function
1	°F/°C	°F/°C (Orange)	Temperature Unit Selection
	OUT1	OUT1 (Orange)	Main control output indicator, lights on when output ON.
	OUT2	OUT2 (Orange)	Cooling output indicator, lights on when output ON.
	AL1	Alarm 1# (Orange)	1st alarm output indicator, lights on when alarm output, lights off when no alarm output.
	AL2	Alarm 2# (Orange)	2nd alarm output indicator, lights on when alarm output, lights off when no alarm output.
	AT	AT (Orange)	Auto tune indicator, lights on when it is under auto tune status.
	COM	COM (Orange)	The communication indicator will keep flashing when communication is in progress
2	SET	SET key	Menu key/confirm key, to enter or exit the modification mode, or to confirm and save the modified parameter.
3	◀	SHIFT/AT key	Activate key/ shift key/ AT auto tune key (in measure and control mode, long press to enter/exit auto tune)
4	⬆	UP key/ R/S	Add key, in measure and control mode, long press it to shift RUN/STOP mode, or check the menu in reverse order.
5	⬇	DOWN key	Reduce key, check the menu in sequence
6	SV	Display (green)	Set value / parameter display window, the control is stopped when it displays "STOP"
7	PV	Display (red)	Measured value/ parameter code display window

### VIII. Operation process and menu illustration

#### 1. Operation process & method

##### 1). Modify SV Value

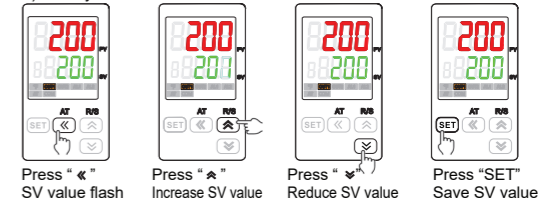

##### 2). Common Menu

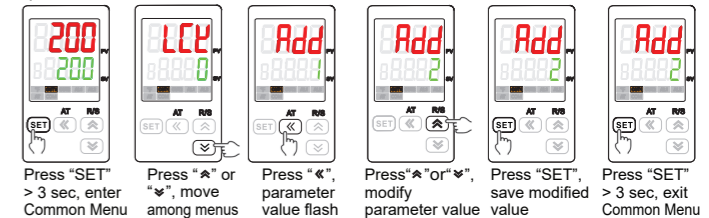

##### 3). Advanced menu

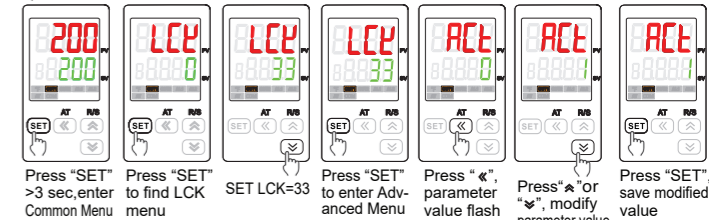



2. Operation examples

1) Example 1, ON/OFF control:

Sensor: K type, measure range -50~1300°C; target temperature: 100°C; control mode: heating; control requirement: ON/OFF control, when current temperature PV reaches 100°C, stop heating, when PV is lower than 98°C, start heating again; control output: relay; alarm: 1 alarm, when PV>110°C, alarm output on; when PV<105°C, alarm output off.

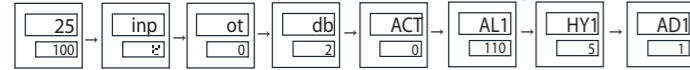

1. Set target temperature SV=100  
2. Set menu INP=K  
3. Set menu OT=0  
4. Set menu DB=2  
5. Set menu ACT=0  
6. Set menu AL1=110  
7. Set menu HY1=5  
8. Set menu AD1=1

2) Example 2, PID control:

Sensor: PT100, measure range -200~600°C; target temperature: 150°C; control mode: heating; control requirement: PID control (note: in order to get stable temperature control, please use the auto-tuning function when the controller is powered on for the first time; if the temperature control is stable after the auto tuning, there is no need to repeat this step in the future usage.); control output: SSR; alarm: 1 alarm, when PV-SV+5°C, alarm output on, when PV-SV-2°C, alarm output off.

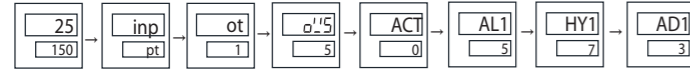

1. Set target temperature SV=150  
2. Set menu INP=pt  
3. Set menu OT=1  
4. Set menu OVS=5  
5. Set menu ACT=0  
6. Set menu AL1=5  
7. Set menu HY1=7  
8. Set menu AD1=3

IX. Menu Illustration

□: No matter what model, what control mode it is, it will always display these parameters.  
■: According to different model, control mode, these parameters will be hidden.

1. Regular Menu

No.	Symbol	Name	Illustration	Setting range	Factory setting
1	AL1	AL1	1st alarm value, note: the minus is dealt as absolute value when it is set as deviation alarm. Refer to (1) Alarm parameters and output logic diagram	FL ~ FH	10
2	HY1	HY1	1st alarm hysteresis	0 ~ 1000	1
3	AD1(1)	AD1(1)	1st alarm mode. Note: when AL1 is used as OUT2 (cooling output), should set AD1=0 (close alarm function). When AD1>6, 2nd alarm function is invalid.	0 ~ 12	3
4	AL2	AL2	2nd alarm value,	FL ~ FH	5
5	HY2	HY2	2nd alarm hysteresis	0 ~ 1000	1
6	AD2(1)	AD2(1)	2nd alarm mode	0 ~ 6	4
7	PS	PS	Amend value, display value= actual measured value + amend value	-1999 ~ 9999	0
8	INP	INP	Optional input signal. Note: after selecting the signal, pls properly set below relevant parameters: SV, AL1, HY1, AL2, HY2, P, OVS, DB.	refer to input signal parameters table (page 3)	K1
9	OT	OT	Control mode, 0: ON/OFF heating control, relevant parameter: DB. 1: PID heating control, relevant parameters: P, I, D, OVS, CP, ST, SPD, PDC. 2: ON/OFF cooling control, relevant parameter DB; need to set PT when it is used for compressor control. 3: PID heating & cooling control (cooling control OUT2 will output through AL1 relay), relevant parameters: P, I, D, OVS, CP, CP1, PC, DB, ST, SPD, PDC. 4: Over temperature cooling output, relevant parameter: DB 5: PID cooling, relevant parameter: P, I, D, OVS, CP, ST, SPD, PDC.	0 ~ 5	1
10	A-M	A-M	Auto-manual control switch, AUTO(0): auto control only; MAN(1): manual control only; AM(2): auto-manual shortcut switch	AUTO-AM	AUTO
11	P	P	Proportional band, the smaller the value is, the faster the system responds, otherwise, it is slower. When P=0, no PID control, unit same as PV	0 ~ 9999	30
12	I	I	Integral time, the smaller the value is, the stronger the integral action is, otherwise, it is weaker. When I=0, no integral action, unit: s.	0 ~ 9999	120
13	D	D	Differential time, the greater the value is, the stronger the differential action is, otherwise, it is weaker. When D=0, no differential action. Set D=0 when controlling fast systems, e.g., pressure, speed, unit: s	0 ~ 9999	30
14	OVS	OVS	Overshoot limit, during PID control process, when PV(measured value) > SV(set value) + OVS (overshoot limit), force to close output. The smaller this value is, the smaller the PID adjustment range is, the worse the control stability is. Please set the appropriate value according to the actual situation.	0 ~ 9999	5
15	CP	CP	OUT1 control cycle, 1: SSR control output, 4-200: relay control output. Unit: s	1 ~ 200	20
16	CP1	CP1	OUT2 relay output cycle. Unit: s	4 ~ 200	20
17	PC	PC	OUT2 cooling proportionality coefficient, the higher of value, the stronger of cooling	0.1 ~ 100.0	10.0
18	DB	DB	ON/OFF control hysteresis (positive and negative numbers work the same); when OT=3, it is the dead zone for cooling control (positive and negative numbers work differently); after change the INP setting, please change this parameter according to the decimal point position.	-1000~1000	5
19	LCK	LCK	Lock function, 0001: SV value can't be modified. 0010: menu set value can be checked only, can't be modified. 0033: enter to advanced menu. 0123: menus reset to factory setting.	0~9999	0

2. Advanced Menu

No.	Symbol	Name	Illustration	Setting range	Factory setting
20	ACT	ACT	Control execution type. 0: relay or SSR output. 1: SSR output (Code type M select this item). 2: 4~20mA control output, 3: 4~20mA retransmission output for size 4/7 products. Note: For size 6/8/9 products, when this menu is set as 0 or 1, 4~20mA output is used as retransmission output.	0~2 (6/8/9 size) 0~3 (4/7 size)	0
21	AE1	AE1	1st alarm extensions function, refer to (2) alarm extension function table	0~5	0
22	AE2	AE2	2nd alarm extensions function, refer to (2) alarm extension function table	0~5	0
23	DP	DP	Decimal point setting, maximum 1 decimal place for TC & RTD input	0~3	0

No.	Symbol	Name	Illustration	Setting range	Factory setting
24	DTR	DTR	PV fuzzy tracking value, properly set this value on some occasions, it can get a more stable control display value, this value is unrelated with actual measured value. Note: after setting this value, when alarm setting value is equal to SV set value, alarm output operation is subject to actual measured value. Set as 0 to close this function.	0.0 ~ 2.0 (0~20)	1.0 (10)
25	FT	FT	Filter coefficient, the higher of value, the stronger of filter function	0 ~ 255	10
26	UT	UT	Temperature unit: °C: Celsius degrees. °F: Fahrenheit degrees. Note: No unit for linear signal	(25)°C (26)°F	(25)°C
27	FL	FL	Measuring range low limit and high limit. For temperature sensor input, please keep the factory setting value. For 4 ~ 20mA / 0 ~ 10V input, please set the corresponding range for the low limit and the high limit. For example, 0~10V corresponds to -20~50, set FL to -20, set FH to 50. Setting range: -1999~9999, associated with DP decimal point menu.	Refer to measured signal parameter table	-50
28	FH	FH	Measuring range low limit and high limit. For example, 0~10V corresponds to -20~50, set FL to -20, set FH to 50. Setting range: -1999~9999, associated with DP decimal point menu.	Refer to measured signal parameter table	1200
29	BRL	BRL	4~20mA analog output low limit and high limit. For example, 4~20mA corresponds to 0~100, set bRL to 0, set bRH to 100. Note: it can be set as reverse analog output, for example, 100~0 corresponds to 4~20mA.	FL~FH	-50
30	BRH	BRH	4~20mA analog output low limit and high limit. For example, 4~20mA corresponds to 0~100, set bRL to 0, set bRH to 100. Note: it can be set as reverse analog output, for example, 100~0 corresponds to 4~20mA.	FL~FH	1200
31	OLL	OLL	Current control output low limit and high limit, only valid for 4~20mA current control output. It is used to limit the output current amplitude. For example, in the control of frequency converter, if the motor cannot be stopped, please set the output low limit OLL to 10%; in heating control, if the user don't want full-power output at the beginning of heating, please set the output high limit OLH to 80%.	-5.0~100.0	0
32	OLH	OLH	Current control output low limit and high limit, only valid for 4~20mA current control output. It is used to limit the output current amplitude. For example, in the control of frequency converter, if the motor cannot be stopped, please set the output low limit OLL to 10%; in heating control, if the user don't want full-power output at the beginning of heating, please set the output high limit OLH to 80%.	0.0 ~ 105.0	100.0
33	ST	ST	Auto-tune activation after power-on, 0: work normally after power-on, 1: automatically enter PID parameters auto-tune status after power-on; long press "AT" key to exit auto-tune.	0~1	0
34	SPD	SPD	PID control speed adjustment, option: 0 (N) no function, 1 (s) slow, 2 (ss) medium slow, 3 (SSS) very slow, 4 (F) fast, 5 (FF) medium fast, 6 (FFF) very fast	0~6	N
35	PDC	PDC	PID algorithm option: 0(FUZ): Advanced fuzzy PID arithmetic; 1(STD): normal PID arithmetic	0~1	FUZ
36	PT	PT	Compressor start delay time, unit: sec	0~9999	0
37	BAD	BAD	Baud rate 0 (4.8): 4800; 1 (9.6): 9600; 2 (19.2): 19200	0~2	9.6
38	ADD	ADD	Modbus Communication ADD	1~247	1
39	PRTY	PRTY	Communication parity check setting, 0: NO 1: ODD 2: EVEN	0~2	NO
40	DTC	DTC	Communication data transport sequence 000; 1st bit function reserved; 2nd bit is byte sequence exchange; 3rd bit function reserved.	Refer to COMM. protocol note③	0
41	CAE	CAE	User self-calibration enable function, this parameter is only for the input signals except TC/RTD; Y: enable the self-calibration parameters; N: don't use the self-calibration parameters.	0 (N) 1 (Y)	N
42	CAL	CAL	Self-calibration low limit input operation, after adding the low end signal to the signal input terminal, flash YES to activate, after confirm and display OK, the input signal low end calibration is completed.	YES/OK	YES
43	CAH	CAH	Self-calibration high limit input operation, after adding the high end signal to the signal input terminal, flash YES to activate, after confirm and display OK, the input signal high end calibration is completed.	YES/OK	YES
44	SSM	SSM	Enable R/S key to switch RUN / STOP operation. 0: Forbidden 1: Enable This setting is only for panel operation, not for communication operation.	0 ~ 1	0
45	VER	VER	Software version, read only		

(1) Alarm parameters and output logic diagram:

Symbol description: "▲" means alarm value, "▲" means SV value

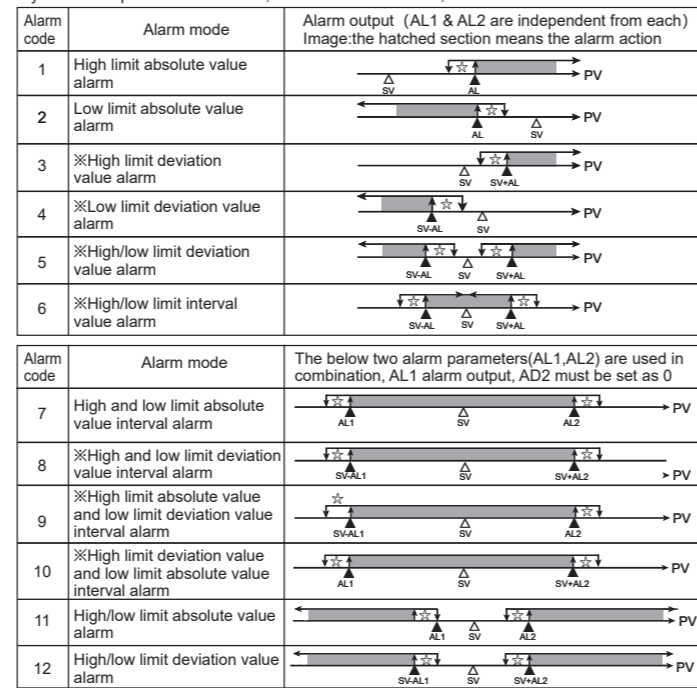

※ For deviation alarm, if alarm value is set as a negative number, it will be used as an absolute value.

(2) Alarm extension function table

AE1/AE2 value	Alarm handling method when it displays HHHH/LLLL	Power on, alarm inhibition
0	Alarm status remains the same	Power on, no alarm inhibition (As long as the alarm condition is met, alarm output immediately.)
1	Forced alarm output	
2	Forced alarm close	
3	Alarm status remains the same	Power on, alarm inhibition (After power on and before the PV value reaches the SV for the first time, the alarm will not output. After that alarm work normally)
4	Forced alarm output	
5	Forced alarm close	

X. Checking methods of simple fault

Display	Checking methods
LLLL/HHHH	Checks whether the input disconnection and whether normal of FH/ FL value, working environment temperature and whether input signal is selected correctly.

XI. Key function operation

- RUN/Stop mode
  - Under the measure mode, press and hold "R/S" key > 3 sec to enter STOP mode, SV window will display "STOP", main control output stops or keep the minimum output.
  - Under STOP mode, press and hold "R/S" key to exit STOP mode. Press " " key to modify SV value.
  - Under STOP mode, alarm output and analog output work normally.
- PID auto-tune operation:
  - Before auto-tuning, please switch off the load power, or set the meter as STOP mode.
  - Before auto-tuning, PV value should meet below condition: when it is PID heating control, PV needs to be much smaller than SV; when it is PID cooling control, PV needs to be much greater than SV.
  - Before auto-tuning, please set a proper alarm value or eliminate the alarm condition, in order to prevent the auto-tuning procedure from being affected by alarm output.
  - Set PID type and SV value; the factory default setting is fuzzy PID.
  - Set as PID control, if there is OLL & OLH output limitation, please set the output to a proper range; factory default setting is OLL=0%, OLH=100%.
  - Exit STOP mode, or switch on the load power, and immediately press and hold "AT" key to enter auto-tuning mode, then the AT indicator light is on.
  - The auto-tuning procedure will take some time, in order not to affect auto-tune result, please don't modify the parameters or power-off.
  - When AT light turns off, it automatically exits auto-tune mode, PID parameters will be updated automatically, and then the meter will control automatically and precisely.
  - During the auto-tuning procedure, below actions will cause the termination of the process, press and hold "AT" key, measure beyond the scope, abnormal display, switch to STOP mode, power-off, etc.
  - Note: In the occasions with output limiting operation, sometimes, even if the auto-tuning is carried out, the best PID parameters still cannot be obtained.
  - Experienced users can set a proper PID parameter according to their experience.
- PID heating and proportional cooling control operation
  - Set the control mode OT as 3.
  - PID heating control operates on OUT1; proportional cooling control operates on OUT2.
  - Proportional cooling control OUT2 outputs via AL1 alarm function terminals.
  - Please set the cooling start hysteresis DB to a value greater than 5, to ensure the cooling output will not affect the PID heating control.
  - Please set the cooling control cycle CP1 and the cooling proportionality coefficient PC to the proper value.
  - When PV value > SV+DB value, the cooling control start to effect; the bigger value of PV, the longer output time of OUT2
- Auto-manual switch function
  - Enter common menu, set parameter A-M as "AM".
  - After return back to measure control interface, press " " key to switch auto-manual operation.
  - When it is switched to manual control, lower line LED will display output percentage: M0-M100 (corresponding to 0%~100%), press UP key and DOWN key to modify the output percentage.
  - Before the switch from manual control to auto control, in order to ensure the smooth switch, please press Shift key to modify the SV value first.
  - After the meter is rebooted, the default setting is manual control and output 0%.

XII. Communication protocol

Meter adopts Modbus RTU communication protocol, RS485 half duplex communication. Read function code 0x03, write function code 0x10 or 0x06. Adopt 16 digit CRC check, the meter does not return for error check. Factory default setting: slave address 1, baud rate 9600, no check, 8 digits data bit, 1 digit stop bit, data type is 16 digits signed (unsigned) int. Data frame format:

Start bit	Data bit	Stop bit	Check bit
1	8	1	Set in Menu PRTY

Handling of abnormal communication:  
When abnormal response, put 1 on the highest bit of function code. For example: Host request function code 0x03, and slave response function code should be 0x83.  
Error code:  
0x01— Illegal function: the function code sent from host is not supported by meter  
0x02— Illegal address: the register address designated by host beyond the address range of meter.  
0x03— Illegal data: the written data value sent from host exceeds the corresponding data range of meter.  
Communication cycle:  
Communication cycle is the time from host request to slave response data, i.e.: communication cycle= time of request data sending + slave preparation time + response delay time + response return time, e.g.: 9600 Baud rate: communication cycle of single measured data ≥250ms.

1. Read register  
For example: Host reads integer SV (set value 200)  
The address code of SV is 0x2000, because SV is integer(2 byte), seizes 1 data register. The memory code of decimal integer 200 is 0x00C8. Note: when reading data, should read DP value or confirm DP menu value first to ensure the decimal point position, after that transform the read data to get the actual value. Conversely, it should transform the data to corresponding ratio before writing the data in meter

Host request (Read multi-register)							
1	2	3	4	5	6	7	8
Meter ADD	Function code	Start ADD high bit	Start ADD low bit	Data byte length high bit	Data byte length low bit	※CRC code low bit	※CRC code high bit
0x01	0x03	0x20	0x00	0x00	0x01	0x8F	0xCA

Slave normal answer(Read multi-register)							
1	2	3	4	5	6	7	8
Meter ADD	Function code	Data byte length	Data high bit	Data low bit	※CRC code low bit	※CRC code high bit	
0x01	0x03	0x02	0x00	0xC8	0xB9	0xD2	

Function code abnormal answer: (For example: host request ADD is 0x2011)				
Slave abnormal answer(Read multi-register)				
1	2	3	8	9
Meter ADD	Function code	Error code	※CRC code low bit	※CRC code high bit
0x01	0x83	0x02	0xC0	0xF1

2. Write multi-register

For example: Host use 0x10 function code write SV (set value 150)  
ADD code of SV is 0x2000, because SV is integer(2 byte), seizes 1 data register. The hexadecimal code of decimal integer 150 is 0x0096.

Host request (write multi-register)										
1	2	3	4	5	6	7	8	9	10	11
Meter ADD	Function code	Start ADD high bit	Start ADD low bit	Data byte length high bit	Data byte length low bit	Data byte length	Data high bit	Data low bit	※CRC code low bit	※CRC code high bit
0x01	0x10	0x20	0x00	0x00	0x01	0x02	0x00	0x96	0x07	0xFC

Slave normal answer (write multi-register)							
1	2	3	4	5	6	7	8
Meter ADD	Function code	Start ADD high bit	Start ADD low bit	Data byte length high bit	Data byte length low bit	※CRC code low bit	※CRC code high bit
0x01	0x10	0x20	0x00	0x00	0x01	0x0A	0x09

Host write SV with 0x06 function (set value 150)							
Host request (write single-register)							
1	2	3	4	5	6	7	8
Meter ADD	Function code	ADD high bit	ADD low bit	Data high bit	Data low bit	※CRC code low bit	※CRC code high bit
0x01	0x06	0x20	0x00	0x00	0x96	0x02	0x64

Slave normal answer (write single-register)							
1	2	3	4	5	6	7	8
Meter ADD	Function code	ADD high bit	ADD low bit	Data high bit	Data low bit	※CRC code low bit	※CRC code high bit
0x01	0x06	0x20	0x00	0x00	0x96	0x02	0x64

Slave abnormal answer (write single-register)				
1	2	3	4	5
Meter ADD	Function code	Error code	※CRC code low bit	※CRC code high bit
0x01	0x86	0x02	0xC3	0xA1

Meter parameters address mapping table

No.	Add(Register No.)	Variable name	Register	R/W	Remark
1	0x2000 (48193)	Set value SV	1	R/W	
2	0x2001 (48194)	1st alarm value AL1	1	R/W	
3	0x2002 (48195)	1st alarm hysteresis HY1	1	R/W	
4	0x2003 (48196)	2nd alarm value AL2	1	R/W	
5	0x2004 (48197)	2nd alarm hysteresis HY2	1	R/W	
6	0x2005 (48198)	Display low limit FL	1	R/W	
7	0x2006 (48199)	Display high limit FH	1	R/W	
8	0x2007 (48200)	Analog output low limit BRL	1	R/W	
9	0x2008 (48201)	Analog output high limit BRH	1	R/W	
10	0x2009 (48202)	Control output low limit OLL	1	R/W	
11	0x200A (48203)	Control output high limit OLH	1	R/W	Default 1 decimal point
12	0x200B (48204)	Overshoot limit OVS	1	R/W	
13	0x200C (48205)	Heat & Cool control dead zone DB	1	R/W	
14	0x200D (48206)	Proportional coefficient of cooling PC	1	R/W	Default 1 decimal point
15	0x200E (48207)	Amend value PS	1	R/W	
16	0x200F (48208)	PV fuzzy tracking value DTR	1	R	Engineering work without decimal point
17	0x2010 (48209)	Measured value PV	1	R	
18	0x2011 (48210)	Output percentage MV	1	R/W	0:Auto; 1: Manual 2:Auto-Manual switch
19	0x2012 (48211)	Auto-Manual switch A-M	1	R/W	
Reserve					
20	0x2100 (48449)	1st alarm mode AD1	1	R/W	
21	0x2101 (48450)	2nd alarm mode AD2	1	R/W	
22	0x2102 (48451)	1st alarm extended function AE1	1	R/W	
23	0				