

CL Series Linespeed/Length Meter Instruction Manual



72H×72W×100L

Features

- ⊙ Two inputs, one measures length, the other is for linespeed.
- ⊙ Linespeed and length rate setting separately.
- ⊙ One output controls length, the other is for linespeed.
- ⊙ Counting speed: 1CPS/30CPS/1KCPS/10KCPS.
- ⊙ Counting rate: 0.00000~999999
- ⊙ Power fail memory function.
- ⊙ 4 kinds of input modes, 8 kinds of output modes.
- ⊙ 3 alarm output.
- ⊙ Rotary sensor doesn't need resistance.
- ⊙ With 485 communication interface.
- ⊙ Widely applied to slide fastener machine, foodstuff machine and packing machine etc.

1. Code illustration

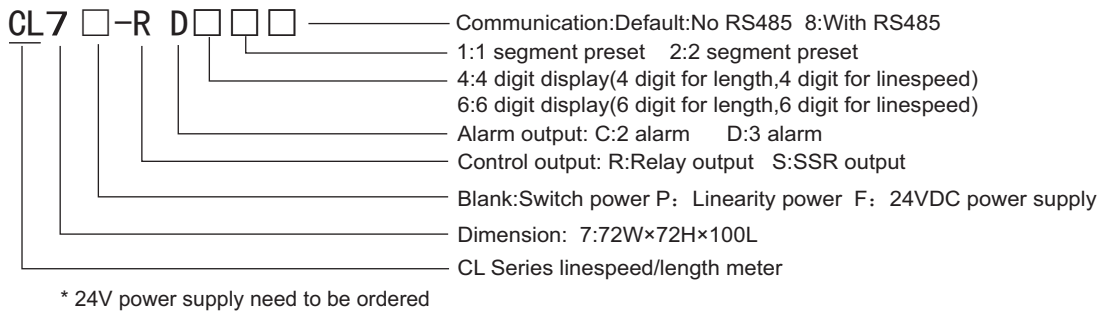

2. Ordering code

No.	Code	Dimension (mm)	Function				
			digit	Batch output	Relay output	Linespeed output	Communication
1	CL7-RC42	72W×72H	4	1 relay	2	No	No
2	CL7-RD428	72W×72H	4	1 relay	3	Yes	Yes
3	CL7-RC62	72W×72H	6	1 relay	2	No	No
4	CL7-RD628	72W×72H	6	1 relay	3	Yes	Yes

3. Technical Specification

voltage	Linearity power AC 220V±10%, 110V±10%, 50/60Hz Switch power AC/DC 85~265V 50/60Hz (DC24V need to be ordered)
Power consumption	<5W
Trigger model	up or down
Data saving	10 years
Input signal (Sine wave, Square wave)	Electrical level: High: 3~30V Low: 0~2V
Counting speed	≤10Kcps
Ambient temperature	0℃~50℃
Interference resistance	Power: 2000V p-p I/O: 100Vp-p
Counting range	-199999~999999 (6 digit), -1999~9999 (4 digit)
Linespeed range	0.00001~999999 (6 digit), 0.001~9999 (4 digit)
Output delay time	0000.01~9999H.99M (6 digit), 00.01~99H99M (4 digit)
Counting output mode	F、N、C、R、K、P、Q、A for option (up/down counting)
input resistance	5.4kΩ
Relay Capacity	AC 250V 3A (resistive load)
Insulation resistance	≥20MΩ
Dielectric strength	AC 1.5KV 1min
Dimension (mm)	48H×48W×100L 72H×72W×100L

1: Parameter setting illustration

No.	Code	Meaning	illustration
1	LCK	function setting	If LCK=4848, enter into high-grade function to set menu; LCK=4848→ADDR→BAUD→S-L→POS→EXIT→Measuring status, press"△" "▷" to modify content.
2	S-L	saving/read menu setting data	SAVE→LOAD: SAVE:Save well-setting data to special space; LOAD:Input data from special space.
3	Pos	choice for saving data position	MEMO→MEM1→MEM2→MEM3
4	Exit	exit menu	YES→NO YES: Save/input data when exit; NO: Don't save/input data when exit. Press RST key: Clean up all memories and exit.
5	Mod	up/down counting mode	"▲": U→d U: positive counting; d: negative counting.
6	In	choice for input mode	Use ▲ to select, total 4 input modes: (Please refer to Pictur A: CP1 counts when it is high electrical level, CP2 is invalid. B: CP1 counts down when CP2 is high level. CP1 counts up when C C: CP1 counts up, CP2 counts down, display value=CP1-CP2 (Up mo D: CP1 counts up when the phase of CP1 leads the one of CP2; CP phase of CP1 lags the one of CP2. This mode is applicable necessary to connect pull-up resistors, but only for NPN m
7	CP	choice for counting speed	"▲"choose different counting speed 1→30→1K→10K
8	P	prescale value setting	shift the flickering digit ▲: change the flickering digit value Prescale value setting range 0.0000001~99999999 Prescale function: converting pulse input to the direct display of length, position or flow value
9	P/dot (dot)	decimal point setting	use "▲"to choose different decimal point position.
10	SI On	Trigger mode	use ▲ key to select rising edge or falling edge triggering / voltage or non voltage input
11	LP	linespeed modulus setting	▶: flicker position moving ▲: change flicker digit value rate setting range: 0.00001~999999
12	HY	alarm hysteresis value	Setting hysteresis value: "▲": change flicker digit value "▶": flicker position moving "RST": change decimal point position of hysteresis value
13	rdIS	display rebrushed time	Setting displayed value rebrushed time of meter、press ▲ key to choose 0: rebrush automatically; 5: rebrush 1time/5S; 0.5: rebrush 1time/0.5S; 10: rebrush 1time/10S; 1: rebrush 1time/1S; 20: rebrush 1time/20S; 2: rebrush 1time/2S;
14	Int	input control signal pulse width	"▲" choose different counting time range 1→10→100→1000 Pulse width setting range: 1-1000, unit: ms Input signal width setting: RESET / BATCH RESET / PAUSE signal
15	out	choice of output mode	Counting mode press"▲" to choose different output control mode. F、N、R、C、K、P、Q、A,(attached B:output motion mode of counter) batch counting/linespeed output mode:F、N、R、C(as above)
16	out1.t (==) out2.t (==)	delay time of output1、2	▶ flicker position moving ▲: change value of flicker digit. RST: change decimal point position of delay time. Minimum delay time: 0.01S. Output delay time:0000.01~9999H.99M(6 digit)、 00.01~99H99M(4 digit)
17	HoL	power fail saving counting value	YES: memory keep function (memorize measuring data, if power is off and repower on,it can continue to count time/number from primary basic) NO: no memory keep function,after repower on,measuring data will clear up to zero.
18	LCK	key lock	▶: flicker position moving ▲: flicker digit value changing Password range: 0000~9999 According to user's four password value,the system can lock or open four different functions seperately: 1:Lock/open SV, only when LCK=0001, SV can't be changed, otherwise SV can be changed; 2:Lock/open RST、BRT, only when LCK=1000, RST、LRT key will be locked, so press RST or LRT won't reset data, otherwise, reset RST、LRT (out-control side of RST and LRT are unlocked 3:Lock/open factory setting function,only whenLCK=0100,in measuring status, press SET+▲ 3S, it flickeringly displays "INIT" 1S and return factory setting. 4:Lock/open menu: only when LCK=0010,lock the menu,users can't modify menu; if LCK isn't 1, set each menu value.

2: SV value setting parameters

No.	Code	Meaning	Illustration	Setting range
1	SV1	Setting value 1 (SV1 light on, it displays.)	Up mode, when measuring value up to setting value SV1, AL1 has output, AL1 light on, reset status=0. down mode, when measuring value down to 0, AL1 has output, AL1 light on, reset status=SV1. "△" key: flicker digit value modifying. "▷"key: digit moving key. SET key: correct modified value. If you set value "0" by careless, Press "SET" key can momentarily display "Error" or "Error", and it can't exit from current status. RST key: decimal point moving key, press it once to move the decimal point to right.	0.001-9999 (4 digit) 0.00001-999999 (6 digit)
2	SV2	Setting value 2 (SV2 light on, it displays.)	Up mode, when measuring value up to setting value SV2, AL2 has output, AL2 light on. Down mode, when measuring value down to setting value SV2(SV1-SV2), AL2 has output, AL2 light on. SET key, RST key as above.	SV1≥P SV2≥P P≥0
3	LSV	Linespeed setting value(LSV light on, it displays.)	Up mode, when measuring value is up to setting value, LAO has output, LAO light on. Down mode, when measuring value is down to setting value, LAO has output, LAO light on. SET key, RST key: As above.	LSV≥LP LP≥0

Attached A: Input mode logic relation chart.

Mode	UP	Down	Illustration
A			CP2:no counting input CP1:counting input
B			UP mode: CP2 no signal input, CP1 increased counting CP2 has signal input, CP1 decreased counting Down mode: CP2 no signal input, CP1 increased counting CP2 has signal input, CP1 decreased counting
C			Up mode: CP1 increased counting, CP2 decreased counting display value=CP1-CP2 Down mode: CP1 decreased, CP2 increased counting display value=CP2-CP1
D			Up mode: CP2 log CP1, CP2 increased counting CP2 lead CP1, CP2 decrease counting Down mode: CP2 log CP1, CP2 decreased counting CP2 lead CP1, CP2 increased counting

Attached B: Counter output action mode

		Input mode		Action after counting to setting value
		Up counting	Down counting	
Output mode	F			Displaying value keep increased/decreased, output will continue to reset input
	N			

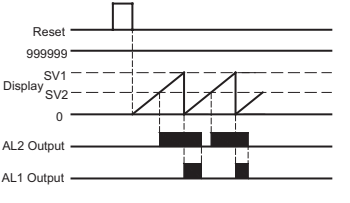
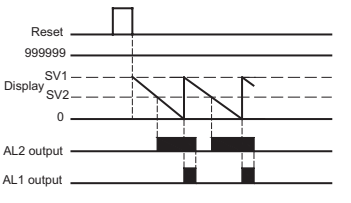
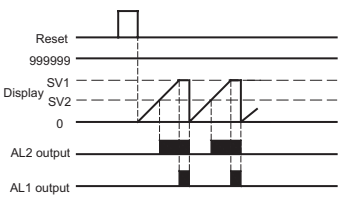
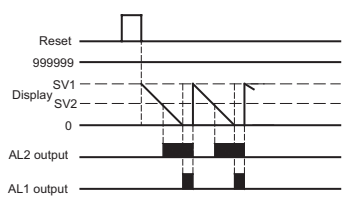
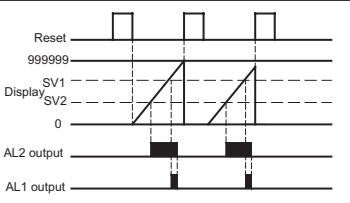
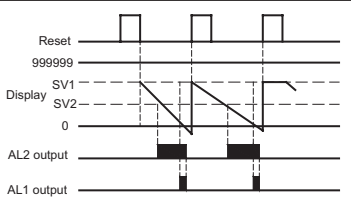
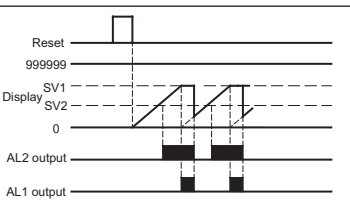
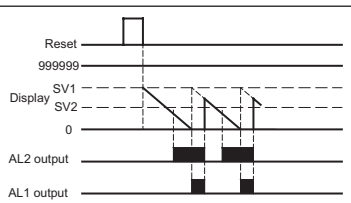
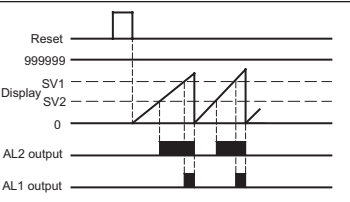
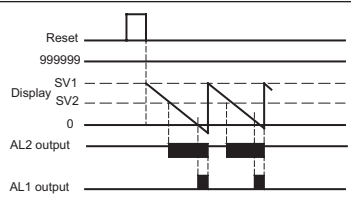
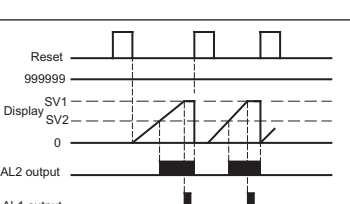
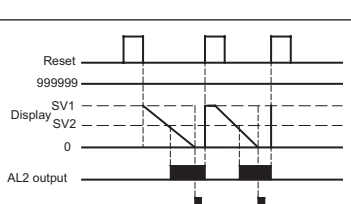
Output mode	C			Display value return to initial status automatically. Output delays to setting time, and then it returns to initial status automatically. (Output action is repeated single output.)
	R			Display value and output delay to setting time and then it returns to initial status automatically. (Output action is repeated single output.)
	K			Display value doesn't continue to increase/decrease until output reset; Output delays to setting time and then returns to initial status. (Output action is single output)
	P			Display value maintains single output delay time, and then it displays next cycle value. In delayed time, display value starts next cycle counting from initial value (Output action is repeated single output)
	Q			Display value continues to increase/decrease in single output/delay time, after single output/delayed time, it returns to initial status. Output delays to setting time and then returns to initial status. (Output action is repeated single output.)
	A			Minimum setting value and AL2 output continues to manual reset input, AL1 output delays to setting time and then returns to initial status. (Output action is single output.)

7. Input connecting

1. Input logic: no voltage input (NPN)

(1) Solid state input

- Standard sensor: NPN output type sensor

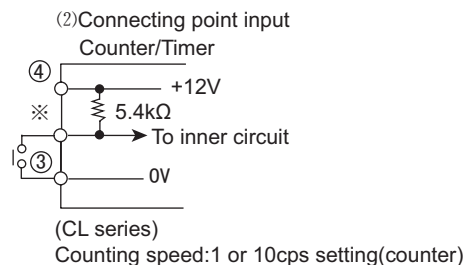
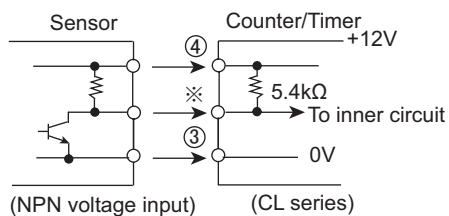

2. Input logic: Voltage input (PNP)

(1) Solid state input

- Standard sensor: PNP output type sensor

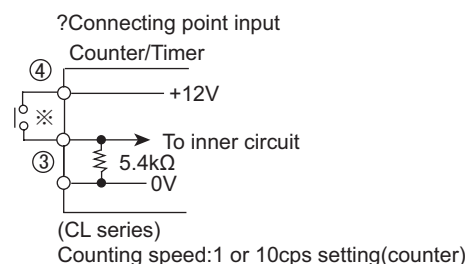
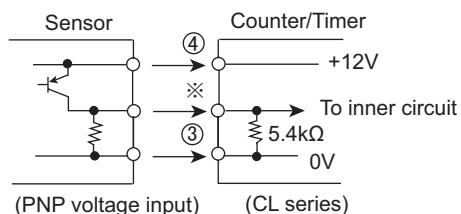

8. Connecting drawing

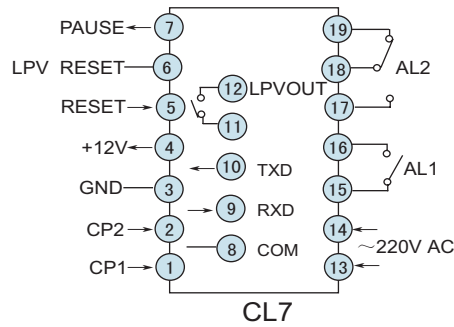

Note: please subject to the diagram on the product if any changes.

9. Mounting dimension

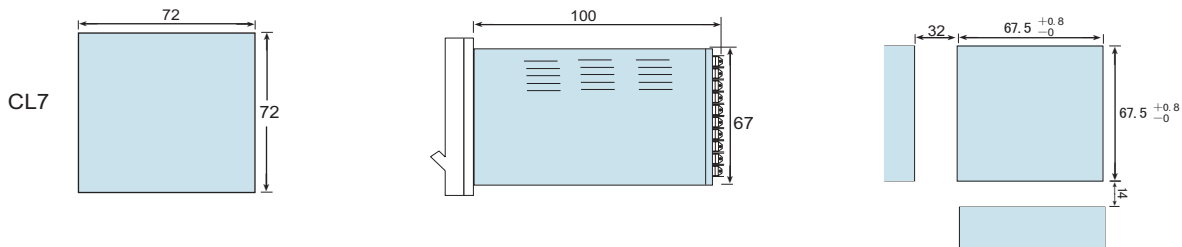

10. Notes

- 1、 In measuring status, external short connect RST connecting drawing port or manually press RST key will activate timing value, counting value and output reset.
- 2、 When counter input mode is d mode, it can match with rotary encoder, and rotary encoder doesn't connec with resistance. (only for NPN)
- 3、 After changing meter's working mode, press "RST"to reset the meter, and then it can measure and control reliably.
- 4、 If meter displays "Error"or "Erro", check parameter "SV1""SV2"accord with logic relation or not. (Logic relation refers to sheet 2)
- 5、 If it has no standard frequency signal, please don't use frequency cabibration menu.
- 6、 Input signal: the distance is short as possible from sensor to timer; you should use shielded line to prolong signal line and seperate it from power line.
- 7、 Counter input connecting:when in high mode(1K、 5K、 10K), if you use connecting point input mode may appear phenomenon of counting too much. So connecting point input mode should set low input (1/30cps).
- 8、 Don't use it in such occasion as below:the place of shaking and impacting seriously; the place of strong acid and alkaline; the place of direct sun's rays; the place of strong magnetic field and electrical interference.
- 9、 Mounting environment: it should be indoor mounting; the altitude is less than 2000M; the pollution grade is 2.

※ If you don't follow it as above, it will bring you some malfunction of products.



Toky Electrical Co.,Ltd.

Add:Civil Science & Technology Park, No.8 Minke West Road,Shiqi North District,
Zhongshan city, Guangdong province, China

China(TEL):0086-760-23371808 (FAX):0086-760-88722611

Http://www.toky.com.cn